

NetModule Router NB3700

User Manual for Software Version 4.1



Manual Version 1.10

NetModule AG, Switzerland

December 14, 2020



NetModule Router NB3700

This manual covers all variants of the *NB3700* product type.

The specifications and information regarding the products in this manual are subject to change without notice. We would like to point out that NetModule makes no representation or warranties with respect to the contents herein and shall not be responsible for any loss or damage caused to the user by the direct or indirect use of this information. This document may contain information about third party products or processes. Such third party information is generally out of influence of NetModule and therefore NetModule shall not be responsible for the correctness or legitimacy of this information. Users must take full responsibility for their application of any products.

Copyright ©2020 NetModule AG, Switzerland All rights reserved

This document contains proprietary information of NetModule. No parts of the work described herein may be reproduced. Reverse engineering of the hardware or software is prohibited and protected by patent law. This material or any portion of it may not be copied in any form or by any means, stored in a retrieval system, adopted or transmitted in any form or by any means (electronic, mechanical, photographic, graphic, optic or otherwise), or translated in any language or computer language without the prior written permission of NetModule.

A large amount of the source code to this product is available under licenses which are both free and open source. Most of it is covered by the GNU General Public License which can be obtained from www.gnu.org. The remainder of the open source software which is not under the GPL, is usually available under one of a variety of more permissive licenses. A detailed license information for a particular software package can be provided on request.

All other products or company names mentioned herein are used for identification purposes only and may be trademarks or registered trademarks of their respective owners. The following description of software, hardware or process of NetModule or other third party provider may be included with your product and will be subject to the software, hardware or other license agreements.

Contact

www.netmodule.com/support

| | |
|--------------------|---|
| NetModule AG | Tel +41 31 985 25 10 |
| Maulbeerstrasse 10 | Fax +41 31 985 25 11 |
| CH-3011 Bern | info@netmodule.com |
| Switzerland | http://www.netmodule.com |

Contents

| | | |
|---------|--|----|
| 1. | Welcome to NetModule | 1 |
| 2. | Conformity | 2 |
| 2.1. | Safety Instructions | 2 |
| 2.2. | Declaration of Conformity | 4 |
| 2.3. | Waste Disposal | 4 |
| 2.4. | National Restrictions | 4 |
| 2.5. | Open Source Software | 5 |
| 3. | Specifications | 6 |
| 3.1. | Appearance | 6 |
| 3.2. | Features | 7 |
| 3.3. | Environmental Conditions | 8 |
| 3.4. | Interfaces | 9 |
| 3.4.1. | Overview | 9 |
| 3.4.2. | LED Indicators | 10 |
| 3.4.3. | Reset | 11 |
| 3.4.4. | Mobile | 12 |
| 3.4.5. | WLAN | 13 |
| 3.4.6. | GNSS | 14 |
| 3.4.7. | USB 2.0 Host Port | 15 |
| 3.4.8. | M12 Ethernet Connectors | 15 |
| 3.4.9. | Power Supply | 16 |
| 3.4.10. | Digital Inputs and Outputs | 18 |
| 3.4.11. | RS-232 Port | 20 |
| 4. | Installation | 22 |
| 4.1. | Installation of the Mini-SIM Cards | 22 |
| 4.2. | Installation of the GSM/UMTS/LTE Antenna | 22 |
| 4.3. | Installation of the WLAN Antennas | 23 |
| 4.4. | Installation of the GPS Antenna | 24 |
| 4.5. | Installation of the Local Area Network | 24 |
| 4.6. | Installation of the Power Supply | 25 |
| 5. | Configuration | 26 |
| 5.1. | First Steps | 26 |
| 5.1.1. | Initial Access | 26 |
| 5.1.2. | Recovery | 27 |
| 5.2. | HOME | 29 |
| 5.3. | INTERFACES | 32 |
| 5.3.1. | WAN | 32 |
| 5.3.2. | Ethernet | 39 |
| 5.3.3. | Mobile | 44 |
| 5.3.4. | WLAN | 49 |
| 5.3.5. | Software Bridges | 57 |
| 5.3.6. | USB | 58 |
| 5.3.7. | Serial Port | 61 |
| 5.3.8. | Digital I/O | 66 |
| 5.3.9. | GNSS | 67 |

| | | |
|---------|------------------------|-----|
| 5.4. | ROUTING | 70 |
| 5.4.1. | Static Routes | 70 |
| 5.4.2. | Extended Routing | 72 |
| 5.4.3. | Multipath Routes | 73 |
| 5.4.4. | Mobile IP | 74 |
| 5.4.5. | Quality Of Service | 77 |
| 5.4.6. | Multicast | 79 |
| 5.4.7. | OSPF | 80 |
| 5.4.8. | BGP | 81 |
| 5.5. | FIREWALL | 82 |
| 5.5.1. | Administration | 82 |
| 5.5.2. | Adress/Port Groups | 82 |
| 5.5.3. | Rules | 83 |
| 5.5.4. | NAPT | 85 |
| 5.6. | VPN | 88 |
| 5.6.1. | OpenVPN | 88 |
| 5.6.2. | IPsec | 94 |
| 5.6.3. | PPTP | 100 |
| 5.6.4. | GRE | 103 |
| 5.6.5. | Dial-In | 104 |
| 5.7. | SERVICES | 105 |
| 5.7.1. | SDK | 105 |
| 5.7.2. | DHCP Server | 114 |
| 5.7.3. | DNS Server | 116 |
| 5.7.4. | NTP Server | 118 |
| 5.7.5. | Dynamic DNS | 119 |
| 5.7.6. | E-Mail | 121 |
| 5.7.7. | Events | 122 |
| 5.7.8. | SMS | 123 |
| 5.7.9. | SSH/Telnet Server | 125 |
| 5.7.10. | SNMP Agent | 127 |
| 5.7.11. | Web Server | 132 |
| 5.7.12. | Discovery | 133 |
| 5.7.13. | Redundancy | 134 |
| 5.7.14. | Voice Gateway | 136 |
| 5.8. | SYSTEM | 142 |
| 5.8.1. | System | 142 |
| 5.8.2. | Authentication | 146 |
| 5.8.3. | Software Update | 149 |
| 5.8.4. | Module Firmware Update | 150 |
| 5.8.5. | Software Profiles | 151 |
| 5.8.6. | Configuration | 152 |
| 5.8.7. | Troubleshooting | 155 |
| 5.8.8. | Keys and Certificates | 158 |
| 5.8.9. | Licensing | 163 |
| 5.8.10. | Legal Notice | 164 |
| 5.9. | LOGOUT | 165 |

| | | |
|-------|------------------------------|-----|
| 6. | Command Line Interface | 166 |
| 6.1. | General Usage | 166 |
| 6.2. | Print Help | 167 |
| 6.3. | Getting Config Parameters | 168 |
| 6.4. | Setting Config Parameters | 168 |
| 6.5. | Checking Config Completed | 168 |
| 6.6. | Getting Status Information | 168 |
| 6.7. | Scanning Networks | 169 |
| 6.8. | Sending E-Mail or SMS | 169 |
| 6.9. | Updating System Facilities | 170 |
| 6.10. | Manage keys and certificates | 170 |
| 6.11. | Restarting Services | 171 |
| 6.12. | Debug System | 171 |
| 6.13. | Resetting System | 172 |
| 6.14. | Rebooting System | 172 |
| 6.15. | Running Shell Commands | 172 |
| 6.16. | Working with History | 173 |
| 6.17. | CLI-PHP | 173 |
| A. | Appendix | 178 |
| A.1. | Abbreviations | 178 |
| A.2. | System Events | 180 |
| A.3. | Factory Configuration | 182 |
| A.4. | SNMP VENDOR MIB | 183 |
| A.5. | SDK Examples | 202 |

List of Figures

| | | |
|-------|----------------------------|-----|
| 5.1. | Initial Login | 27 |
| 5.2. | Home | 29 |
| 5.3. | WAN Links | 32 |
| 5.4. | WAN Settings | 36 |
| 5.5. | Link Supervision | 37 |
| 5.6. | Ethernet Ports | 39 |
| 5.7. | Ethernet Link Settings | 40 |
| 5.8. | VLAN Management | 41 |
| 5.9. | LAN IP Configuration | 42 |
| 5.10. | SIMs | 44 |
| 5.11. | WWAN Interfaces | 47 |
| 5.12. | WLAN Management | 49 |
| 5.13. | WLAN Configuration | 54 |
| 5.14. | WLAN IP Configuration | 56 |
| 5.15. | USB Administration | 58 |
| 5.16. | USB Device Management | 59 |
| 5.17. | Serial Port Administration | 61 |
| 5.18. | Serial Port Settings | 63 |
| 5.19. | Digital I/O Ports | 66 |
| 5.20. | Static Routing | 70 |
| 5.21. | Extended Routing | 72 |
| 5.22. | Multipath Routes | 73 |
| 5.23. | Mobile IP | 76 |
| 5.24. | Firewall Groups | 82 |
| 5.25. | Firewall Rules | 83 |
| 5.26. | Masquerading | 85 |
| 5.27. | Inbound NAT | 86 |
| 5.28. | OpenVPN Administration | 88 |
| 5.29. | OpenVPN Configuration | 89 |
| 5.30. | OpenVPN Client Management | 93 |
| 5.31. | IPsec Administration | 95 |
| 5.32. | IPsec Configuration | 96 |
| 5.33. | PPTP Administration | 100 |
| 5.34. | PPTP Tunnel Configuration | 101 |
| 5.35. | PPTP Client Management | 102 |
| 5.36. | Dial-in Server Settings | 104 |
| 5.37. | SDK Administration | 109 |
| 5.38. | SDK Jobs | 110 |
| 5.39. | DHCP Server | 114 |
| 5.40. | DNS Server | 116 |
| 5.41. | NTP Server | 118 |
| 5.42. | Dynamic DNS Settings | 119 |
| 5.43. | E-Mail Settings | 121 |
| 5.44. | SMS Configuration | 123 |

| | | |
|-------|--------------------------------------|-----|
| 5.45. | SSH and Telnet Server | 125 |
| 5.46. | SNMP Agent | 128 |
| 5.47. | Web Server | 132 |
| 5.48. | VRRP Configuration | 134 |
| 5.49. | Voice Gateway Administration | 136 |
| 5.50. | Voice Gateway Endpoint Configuration | 137 |
| 5.51. | Voice Gateway Routing Configuration | 140 |
| 5.52. | System | 142 |
| 5.53. | Regional settings | 145 |
| 5.54. | User Accounts | 146 |
| 5.55. | Remote Authentication | 147 |
| 5.56. | Manual File Configuration | 152 |
| 5.57. | Automatic File Configuration | 153 |
| 5.58. | Factory Configuration | 154 |
| 5.59. | Log Viewer | 156 |
| 5.60. | Tech Support File | 157 |
| 5.61. | Keys and certificates | 158 |
| 5.62. | Certificate Configuration | 160 |
| 5.63. | Licensing | 163 |

List of Tables

| | | |
|--------|---|-----|
| 3.1. | Environmental Conditions | 8 |
| 3.2. | NB3700 Interfaces | 10 |
| 3.3. | NB3700 Status Indicators | 11 |
| 3.4. | Ethernet Status Indicators | 11 |
| 3.5. | Mobile Interface | 12 |
| 3.6. | Mobile Antenna Port Specification | 12 |
| 3.7. | IEEE 802.11 Standards | 13 |
| 3.8. | WLAN Antenna Port Specification | 13 |
| 3.9. | GNSS Specifications option G | 14 |
| 3.10. | GNSS Specifications option Ge | 14 |
| 3.11. | GNSS / GPS Antenna Port Specification | 14 |
| 3.12. | USB 2.0 Host Port Specification | 15 |
| 3.13. | Ethernet Port Specification | 15 |
| 3.14. | Pin Assignments of Ethernet Connectors | 16 |
| 3.15. | Power Input Specifications Variant Pa | 16 |
| 3.16. | Power Input Specifications Variant Pb | 17 |
| 3.17. | Pin Assignments of Power Connector | 17 |
| 3.18. | Common Digital I/O Specification | 18 |
| 3.19. | Isolated Digital Outputs Specification | 18 |
| 3.20. | Isolated Digital Inputs Specification | 18 |
| 3.21. | Pin Assignments of Digital Inputs and Outputs | 19 |
| 3.22. | Non-isolated RS-232 Port Specification | 19 |
| 3.23. | Pin Assignments of RS-232 instead of Digital Input/Output | 20 |
| 3.24. | Non-isolated RS-232 Port Specification | 20 |
| 3.25. | Pin Assignments of RS-232 Port | 21 |
| 4.1. | LTE/UMTS antenna port types | 23 |
| 4.2. | WLAN antenna port types | 23 |
| 5.20. | IEEE 802.11 Network Standards | 51 |
| 5.43. | Static Route Flags | 71 |
| 5.89. | SMS Control Commands | 113 |
| 5.99. | SMS Number Expressions | 124 |
| 5.135. | Certificate Sections | 159 |
| 5.136. | Certificate Operations | 159 |
| A.1. | Abbreviations | 179 |
| A.2. | System Events | 181 |
| A.3. | SDK Examples | 204 |



1. Welcome to NetModule

Thank you for purchasing a NetModule Router. This document should give you an introduction to the router and its features. The following chapters describe any aspects of commissioning the device, installation procedure and provide helpful information towards configuration and maintenance.

Please find further information such as sample SDK script or configuration samples in our wiki on <http://wiki.netmodule.com>.

2. Conformity

This chapter provides general information for putting the router into operation.

2.1. Safety Instructions

Please carefully observe all safety instructions in the manual that are marked with the symbol .



Compliance information: The NetModule routers must be used in compliance with any and all applicable national and international laws and with any special restrictions regulating the utilization of the communication module in prescribed applications and environments.



Information about the accessories / changes to the device:

- Please only use original accessories to prevent injuries and health risks.
- Changes made to the device or the use of non-authorized accessories will render the warranty null and void and potentially invalidate the operating license.
- NetModule routers must not be opened (SIM cards may be used according to the instructions).



Information about the device interfaces:

- All systems that are connected to the NetModule router interfaces must meet the requirements for SELV (Safety Extra Low Voltage) systems.
- Interconnections must not leave the building nor penetrate the body shell of a vehicle.
- Connections for antennas may only exit the building or the vehicle hull if transient overvoltages (according to IEC 62368-1) are limited by external protection circuits down to 1 500 V_{peak}. All other connections must remain within the building or the vehicle hull.
- Always keep a distance of more than 40 cm from the antenna in order to reduce exposure to electromagnetic fields below the legal limits.
- Devices with a WLAN interface may be operated only with applicable Regulatory Domain configured. Special attention must be paid to country, number of antennas and the antenna gain (see also chapter 5.3.4). The maximum allowed gain is 3dBi in the relevant frequency range. WLAN antennas with a higher amplification may be used with the NetModule router "Enhanced-RF-Configuration" software license and the antenna gain and cable attenuation that have been correctly configured by certified specialized personnel. A misconfiguration will lead to loss of the approval.
- Cellular antennas attached to the router must have an antenna gain of equal or less than 2.5 dBi. The user is responsible for the compliance with the legal regulations.
- Only CE-compliant power supplies with a current-limited SELV output voltage range may be used with the NetModule routers.¹

¹**Note:** Power supplies for routers with the Pb option (72-110 V_{DC}) cannot be a SELV circuit, since the voltage is greater than 60 V_{DC}.



General safety instructions:

- Observe the usage limitations of radio units at filling stations, in chemical plants, in systems with explosives or potentially explosive locations.
- The devices may not be used in airplanes.
- Exercise particular caution near personal medical aids, such as pacemakers and hearing aids.
- The NetModule routers may also cause interference in the nearer distance of TV sets, radio receivers and personal computers.
- Never perform work on the antenna system during a thunderstorm.
- The devices are generally designed for normal indoor use. Do not expose the devices to extraordinary environmental conditions worse than IP40.
- Protect them against aggressive chemical atmospheres and humidity or temperatures outside specifications.
- We highly recommended creating a copy of a working system configuration. It can be easily applied to a newer software release afterwards.

2.2. Declaration of Conformity



NetModule hereby declares that under our own responsibility that the routers comply with the relevant standards following the provisions of the *RED Directive 2014/53/EU*. The signed version of the *Declaration of Conformity* can be obtained from <http://www.netmodule.com/downloads>

2.3. Waste Disposal



In accordance with the requirements of the *Council Directive 2012/19/EU* regarding Waste Electrical and Electronic Equipment (WEEE), you are urged to ensure that this product will be segregated from other waste at end-of-life and delivered to the WEEE collection system in your country for proper recycling.

2.4. National Restrictions

This product may be generally used in all EU countries (and other countries following the *RED Directive 2014/53/EU*) without any limitation. Please refer to our WLAN Regulatory Database for getting further national radio interface regulations and requirements for a particular country.

2.5. Open Source Software

We inform you that NetModule products may contain in part open-source software. We are distributing such open-source software to you under the terms of GNU General Public License (GPL)², GNU Lesser General Public License (LGPL)³ or other open-source licenses⁴. These licenses allow you to run, copy, distribute, study, change and improve any software covered by GPL, Lesser GPL, or other open-source licenses without any restrictions from us or our end user license agreement on what you may do with that software. Unless required by applicable law or agreed to in writing, software distributed under open-source licenses is distributed on an "AS IS" basis, WITHOUT WARRANTIES OR CONDITIONS OF ANY KIND, either express or implied.

To obtain the corresponding open source codes covered by these licenses, please contact our technical support at router@support.netmodule.com.

Acknowledgements

This product includes:

- PHP, freely available from <http://www.php.net>
- Software developed by the OpenSSL Project for use in the OpenSSL Toolkit (<http://www.openssl.org>)
- Cryptographic software written by Eric Young (eay@cryptsoft.com)
- Software written by Tim Hudson (tjh@cryptsoft.com)
- Software written Jean-loup Gailly and Mark Adler
- MD5 Message-Digest Algorithm by RSA Data Security, Inc.
- An implementation of the AES encryption algorithm based on code released by Dr Brian Gladman
- Multiple-precision arithmetic code originally written by David Ireland
- Software from The FreeBSD Project (<http://www.freebsd.org>)

²Please find the GPL text under <http://www.gnu.org/licenses/gpl-2.0.txt>

³Please find the LGPL text under <http://www.gnu.org/licenses/lgpl.txt>

⁴Please find the license texts of OSI licenses (ISC License, MIT License, PHP License v3.0, zlib License) under <http://opensource.org/licenses>

3. Specifications

3.1. Appearance

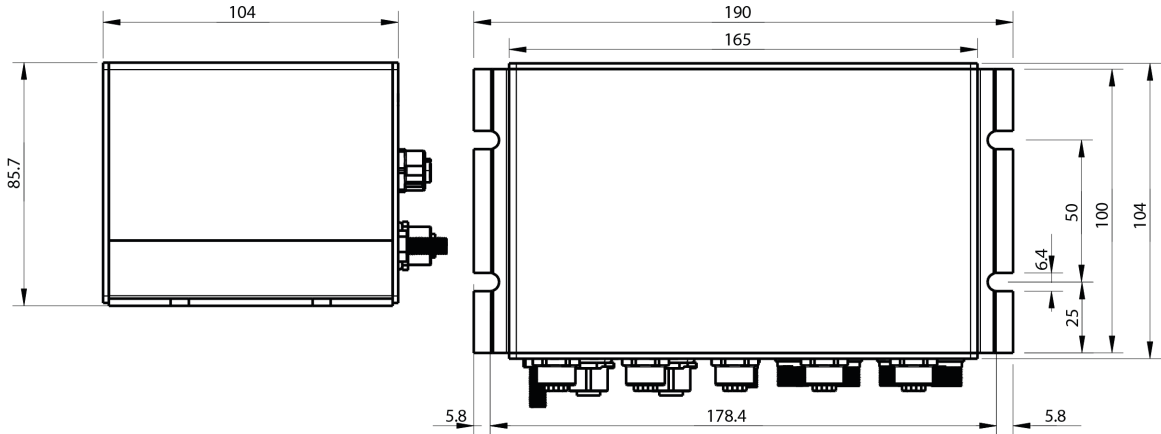
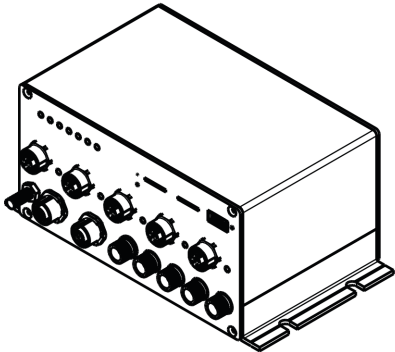
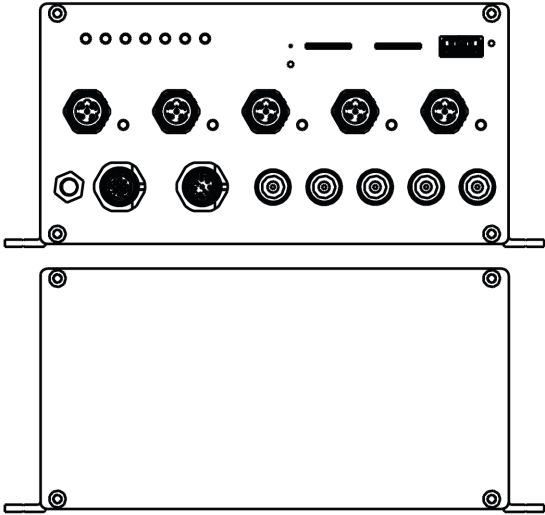

3.2. Features

All models of NB3700 have the following standard functionalities:

- Galvanically isolated power supply
- 5 Ethernet ports (M12, 10/100 Mbit/s)
- 2 digital inputs, 2 digital outputs
- 1 USB 2.0 host port
- 2 mini SIM card slots

The NB3700 can be equipped with the following options:

- LTE
- GSM-R
- WLAN IEEE 802.11abgn
- GPS/GNSS
- Power Supply 72 , 96, 110 VDC
- 64 GB internal storage
- Software Key Server
- Software Key Voice

Note:All LTE models include support for UMTS/EDGE/GPRS.

Due to its modular approach, the NB3700 router and its hardware components can be arbitrarily assembled according to its indented usage or application. Please contact us in case of special project requirements.

3.3. Environmental Conditions

| Parameter | Rating |
|-----------------------------|---|
| Input Voltage (Variant Pa) | 12 V _{DC} to 48 V _{DC} (−15% / +30%) |
| Input Voltage (Variant Pb) | 72 V _{DC} to 110 V _{DC} (−30% / +30%) |
| Operating Temperature Range | 12-48 V _{DC} : EN50155 TX (−40 °C to +70 °C) with max. 2 radio modules 72-110 V _{DC} : EN50155 TX (−40 °C to +70 °C) with max. 2 radio modules |
| Storage Temperature Range | −40 °C to +85 °C |
| Humidity | 0 to 95% (non-condensing) |
| Altitude (Variant Pa) | up to 4000m |
| Altitude (Variant Pb) | up to 2000m |
| Over-Voltage Category | I |
| Pollution Degree | 2 |
| Ingress Protection Rating | IP40 (with SIM and USB covers mounted) |

Table 3.1.: Environmental Conditions



Attention: When using the Pb variant with an input voltage higher than 60 V_{DC}, the router MUST be connected to an earth protection.

3.4. Interfaces

3.4.1. Overview

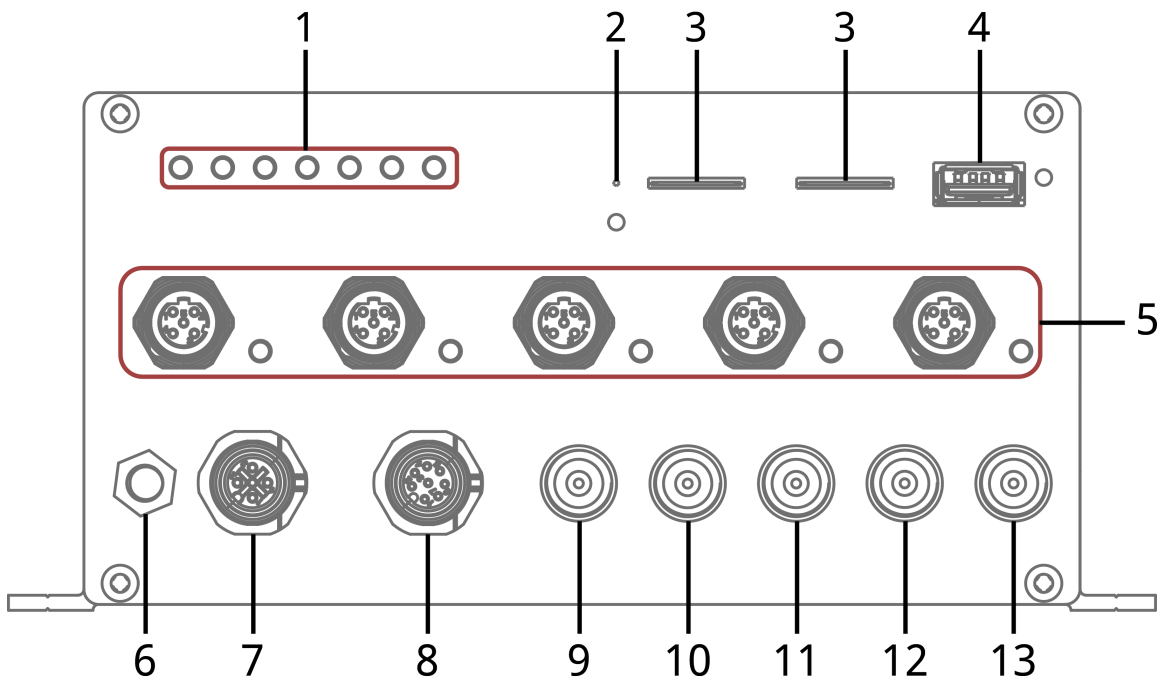

| Nr. | Label | Function |
|-----|---|--|
| 1 | LED Indicators | LED Indicators for the different interfaces |
| 2 | Reset | Reboot and factory reset button |
| 3 | SIM 1-2 | SIM 1-2, they can be assigned dynamically to any modem by configuration. |
| 4 | USB | USB 2.0 host port, can be used for software/configuration updates. |
| 5 | Ethernet 1-5 | FastEthernet switch ports, can be used as LAN or WAN interface. |
| 6 |  | Earth protection connector, connected to the ground of the power supply V_{GND} . If used, connect a yellow-green marked cable with at least $6mm^2$ copper area. Avoid corrosion and protect the screws against loosening. Earthing is mandatory for the variant Pb (50V_{DC} to 136V_{DC} power supply). |
| 7 | Power | Power supply (galvanically isolated) |
| 8 | Digital I/O | Galvanically isolated digital I/O M12 connector |
| 9 | Mob 1 | TNC female connector for mobile antenna 1 |
| 10 | WLAN 1 | TNC female connector for first WLAN antenna (main) |



















| Nr. | Label | Function |
|-----|--------|--|
| 11 | GPS | TNC female connector for GPS antenna |
| 12 | Mob 2 | TNC female connector for mobile antenna 2 |
| 13 | WLAN 2 | TNC female connector for second WLAN antenna (diversity) |

Table 3.2.: NB3700 Interfaces

3.4.2. LED Indicators

Status LEDs

The following table describes the NB3700 status indicators.

| Label | Color | State | Function |
|--------|--|----------|--|
| Status |  | blinking | The device is busy due to startup, software or configuration update. |
| |  | on | The device is ready. The captions of the top bank apply. |
| |  | on | The device is ready. The captions of the bottom bank apply. |
| Mob1 |  ^[1] | on | Mobile connection 1 is up. |
| |  | blinking | Mobile connection 1 is being established. |
| |  | off | Mobile connection 1 is down. |
| Mob2 |  ^[1] | on | Mobile connection 2 is up. |
| |  | blinking | Mobile connection 2 is being established. |
| |  | off | Mobile connection 2 is down. |
| VPN |  | on | VPN connection is up. |
| |  | off | VPN connection is down. |
| WLAN |  ^[1] | on | WLAN connection is up. |
| |  | blinking | WLAN connection is being established. |
| |  | off | WLAN connection is down. |
| GPS |  | on | GPS is turned on and a valid NMEA stream is available. |
| |  | blinking | GPS is searching for satellites. |
| |  | off | GPS is turned off or no valid NMEA stream is available. |
| Voice |  | on | A voice call is currently active. |
| |  | off | No voice call is active. |

| Label | Color | State | Function |
|-------|-------|-------|--|
| DO1 | ● | on | Normally open output port 1 is closed. |
| | ○ | off | Normally open output port 1 is open. |
| DO2 | ● | on | Normally closed output port 2 is closed. |
| | ○ | off | Normally closed output port 2 is open. |
| DI1 | ● | on | Input port 1 is set. |
| | ○ | off | Input port 1 is not set. |
| DI2 | ● | on | Input port 2 is set. |
| | ○ | off | Input port 2 is not set. |

^[1] The color of the LED represents the signal quality for wireless links.

- red means low
- yellow means moderate
- green means good or excellent

Table 3.3.: NB3700 Status Indicators

Ethernet LEDs

The following table describes the Ethernet status indicators.

| Label | Color | State | Function |
|--------------|-------|----------|--|
| Ethernet 1-5 | ● | on | Link on (10 Mbit/s, 100 Mbit/s or 1000 Mbit/s) |
| | ● | blinking | Activity |
| | ○ | off | no Link |

Table 3.4.: Ethernet Status Indicators

3.4.3. Reset

The reset button has two functions:

1. Reboot the system:
Press at least 3 seconds to release a system reboot.
The reboot is indicated with the red blinking STAT LED.
2. Factory reset:
Press at least 10 seconds to release a factory reset.
The start of the factory reset is confirmed by all LEDs lighting up for a second.

3.4.4. Mobile

The various variants of the NB3700 support up to 2 WWAN modules for mobile communication.

| Standard | Bands | Data rate |
|---------------------|--|--|
| 4G (LTE/FDD) | B1(2100), B2(1900), B3(1800), B5(850), B7(2600), B8(900), B20(800) | Downlink: 100 Mbit/s Uplink: 50 Mbit/s |
| 3G (DC-HSPA+/UMTS) | B5(850), B8(900), B2(1900), B1(2100) | Downlink: 42 Mbit/s Uplink: 5.76 Mbit/s |
| 2G (EDGE/GPRS/GSM) | B9(900), B3(1800), B2(1900) | Downlink: 236.8 kbit/s Uplink: 236.8 kbit/s |
| LTE450 | LTE Band 3 (1800 MHz), LTE Band 7 (2600 MHz), LTE Band 20 (800 MHz), LTE Band 31 (450 MHz), UMTS Band 1 (2100 MHz), UMTS Band 8 (900 MHz) | Downlink: 100 Mbit/s Uplink: 50 Mbit/s |
| LTE Advanced Cat. 6 | B30 (2300 WCS), B41 (TDD 2500), B29 (US 700de Lower), B26 (US 850 Ext), B25 (1900), B5 (850), B20 (800DD), B13 (700c), B12 (700ac), B7 (2600), B4 (AWS), B3 (1800), B2 (1900), B1 (2100) | Downlink: 300 Mbit/s Uplink: 50 Mbit/s |

Table 3.5.: Mobile Interface

Note: This enumeration is not meant to be exhaustive.
The LTE modules support 2x2 MIMO.

The mobile antenna ports have the following specification:

| Feature | Specification |
|---|---------------|
| Max. allowed cable length | 30 m |
| Max. allowed antenna gain including cable attenuation | 2.5 dBi |
| Min. distance between collocated radio transmitter antennas (Example: MOB1 to MOB2) | 20 cm |
| Min. distance between people and antenna | 40 cm |
| Connector type | TNC |

Table 3.6.: Mobile Antenna Port Specification

3.4.5. WLAN

The variants of the NB3700 support up to 2 802.11 a/b/g/n WLAN modules. Each can operate either as client or access point.

| Standard | Frequencies | Bandwidth | Data Rate |
|----------|-------------|-----------|------------|
| 802.11a | 5 GHz | 20 MHz | 54 Mbit/s |
| 802.11b | 2.4 GHz | 20 MHz | 11 Mbit/s |
| 802.11g | 2.4 GHz | 20 MHz | 54 Mbit/s |
| 802.11n | 2.4/5 GHz | 20/40 MHz | 300 Mbit/s |

Table 3.7.: IEEE 802.11 Standards

Note: 802.11n supports 2x2 MIMO

The WLAN antenna ports have the following specification:

| Feature | Specification |
|--|----------------------|
| Max. allowed cable length | 30 m |
| Max. allowed antenna gain including cable attenuation | 3.0 dBi ¹ |
| Min. distance between collocated radio transmitter antennas (Example: WLAN1 to MOB1) | 20 cm |
| Min. distance between people and antenna | 40 cm |
| Connector type | TNC |

Table 3.8.: WLAN Antenna Port Specification

¹**Note:** WLAN antennas with a higher amplification may be used with the NetModule router "Enhanced-RF-Configuration" software license and the antenna gain and cable attenuation that have been correctly configured by certified specialized personnel.

3.4.6. GNSS

GNSS (Option G)

The GNSS is used from a WWAN Module.

| Feature | Specification |
|----------------------|--------------------|
| Systems | GPS/GLONASS |
| Data stream | JSON or NMEA |
| Tracking sensitivity | -154 dBm |
| Supported antennas | Active and passive |

Table 3.9.: GNSS Specifications option G

GNSS (Option Ge)

The GNSS module supports Dead Reckoning with onboard 3D accelerometer and 3D gyroscope.

| Feature | Specification |
|----------------------|---------------------------------|
| Systems | GPS/GLONASS/BeiDu/Galileo ready |
| Data stream | NMEA or UBX |
| Tracking sensitivity | -160 dBm |
| Channels | 72 |
| Accuracy | 2m |
| Supported antennas | Active and passive |

Table 3.10.: GNSS Specifications option Ge

The GNSS antenna port have the following specification:

| Feature | Specification |
|--|---------------|
| Max. allowed cable length | 30 m |
| Max. allowed antenna gain | 3.0 dBi |
| Min. distance between collocated radio transmitter antennas (Example: WLAN1 to MOB1) | 20 cm |
| Connector type | TNC |

Table 3.11.: GNSS / GPS Antenna Port Specification

3.4.7. USB 2.0 Host Port

The USB 2.0 host port has the following specification:

| Feature | Specification |
|-------------------|----------------------|
| Speed | Low, Full & Hi-Speed |
| Current | max. 500 mA |
| Max. cable length | 3 m |
| Cable shield | mandatory |
| Connector type | Type A |

Table 3.12.: USB 2.0 Host Port Specification

3.4.8. M12 Ethernet Connectors

Specification

The five Ethernet ports have following specification:

| Feature | Specification |
|------------------------|--|
| Isolation to enclosure | 1000 V _{AC} or 1414 V _{DC} |
| Speed | 10/100 Mbit/s |
| Mode | Half- & Full-Duplex |
| Crossover | Automatic MDI/MDI-X |
| Max. cable length | 100 m |
| Cable type | CAT5e or better |
| Cable shield | mandatory |
| Connector type | M12 d-coded |

Table 3.13.: Ethernet Port Specification

Pin Assignment on M12, 4 poles, D-coded female

| Pin | Signal | Pinning |
|-----|--------|---------|
| 1 | Tx+ | |
| 2 | Rx+ | |
| 3 | Tx- | |
| 4 | Rx- | |

Table 3.14.: Pin Assignments of Ethernet Connectors

3.4.9. Power Supply

Standard variant Pa (12 V_{DC} to 48 V_{DC})

The power input has the following specifications:

| Feature | Specification |
|-------------------------------|---|
| Power supply nominal voltages | 24 V _{DC} , 36 V _{DC} and 48 V _{DC} (according to EN 50155) |
| Voltage range | 12 V _{DC} to 48 V _{DC} (-15% / +30%) |
| Max. power consumption | 15 W |
| Typ. Inrush-Current-Integral | 0.23 A ² s at 24 V _{in} 0.57 A ² s at 36 V _{in} 1.05 A ² s at 48 V _{in} |
| Max. cable length | 30m |
| Cable shield | not required |
| Galvanic isolation | yes, 1500 V _{DC} (according to EN 50155 & EN 60950) |
| Power interruption | Class S2: Sustains power interruptions up to 10 ms No batteries included |
| Supply change over | Class C1: 0.6 U _n during 100 ms (w/o interruption) |
| Connector type | M12, 4 poles, A-coded male |

Table 3.15.: Power Input Specifications Variant Pa

Variant Pb (72 V_{DC} to 110 V_{DC})

The power input has the following specifications:

| Feature | Specification |
|-------------------------------|--|
| Power supply nominal voltages | 72 V _{DC} , 96 V _{DC} and 110 V _{DC} (according to EN 50155) |
| Voltage range | 72 V _{DC} to 110 V _{DC} (-30% / +30%) |
| Max. power consumption | 15 W |
| Typ. Inrush-Current-Integral | 0.07 A ² s at 72 V _{in} 0.13 A ² s at 96 V _{in} 0.18 A ² s at 110 V _{in} |
| Max. cable length | 30m |
| Cable shield | not required |
| Galvanic isolation | yes, 1500 V _{rms} (according to EN 50155 & EN 60950) |
| Power interruption | Class S2: Sustains power interruptions up to 10 ms No batteries included |
| Supply change over | Class C1: 0.6 U _n during 100 ms (w/o interruption) |
| Connector type | M12, 4 poles, A-coded male |

Table 3.16.: Power Input Specifications Variant Pb

Pin Assignment M12, 4 poles, A-coded male

| Pin | Signal | Pinning |
|-----|---|---|
| 1 | V+ (12–48 V _{DC} or 72–110 V _{DC}) |  |
| 2 | Not connected | |
| 3 | V _{GND} | |
| 4 | Not connected | |

Table 3.17.: Pin Assignments of Power Connector

3.4.10. Digital Inputs and Outputs

The isolated input and oputput ports have the following specification in common:

| Feature | Specification |
|----------------------------|-----------------------|
| Isolation to enclosure/GND | 1'000 V _{AC} |
| Isolation to adjacent I/O | functional |
| Max. cable length | 10 m |
| Cable shield | not required |

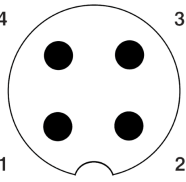
Table 3.18.: Common Digital I/O Specification

Isolated Outputs

The isolated digital output ports have the following specification:

| Feature | Specification |
|-----------------------------|---|
| Number of output ports | 2 |
| Limiting continuous current | 1 A |
| Maximum switching voltage | 60 V _{DC} , 42 V _{AC} (V _{rms}) |
| Maximum switching capacity | 60 W |

Table 3.19.: Isolated Digital Outputs Specification

Isolated Inputs

The isolated digital input ports have the following specification:

| Feature | Specification |
|---------------------------------------|---------------------|
| Number of inputs | 2 |
| Maximum input voltage | 40 V _{DC} |
| Minimum voltage for level 1 (set) | 7.2 V _{DC} |
| Maximum voltage for level 0 (not set) | 5.0 V _{DC} |

Table 3.20.: Isolated Digital Inputs Specification

Note: A negative input voltage is not recognized.

Pin Assignment M12 8-pole A-coded female

| Pin | Signal | Pinning |
|-----|--|---------|
| 1 | DI1+ | |
| 2 | DI1– | |
| 3 | DI2+ | |
| 4 | DI2– | |
| 5 | DO1: Dry contact relay normally open | |
| 6 | DO1: Dry contact relay normally open | |
| 7 | DO2: Dry contact relay normally closed | |
| 8 | DO2: Dry contact relay normally closed | |

Table 3.21.: Pin Assignments of Digital Inputs and Outputs

Option Serial Interface

Instead of the digital input and output, the internal non isolated serial interface could be placed. This 3-wire RS-232 port has the following specification (bold characters show the default configuration):

| Feature | Specification |
|---------------------------------|--|
| Protocol | 3-wire RS-232: GND, TXD, RXD |
| Baud rate | 300, 1 200, 2 400, 4 800, 9 600, 19 200, 38 400, 57 600, 115 200 , 230 400, 460 800 |
| Data bits | 7 bit, 8 bit |
| Parity | none , odd, even |
| Stop bits | 1 , 2 |
| Software flow control | none , XON/XOFF |
| Hardware flow control | none |
| Galvanic isolation to enclosure | none |
| Max. cable length | 10 m |
| Cable shield | mandatory |

Table 3.22.: Non-isolated RS-232 Port Specification

Pin Assignment M12 8-pole A-coded female

| Pin | Signal | Pinning |
|-----|--------|---------|
| 1 | GND | |
| 2 | TxD | |
| 3 | RxD | |
| 4 | – | |
| 5 | – | |
| 6 | – | |
| 7 | – | |
| 8 | – | |

Table 3.23.: Pin Assignments of RS-232 instead of Digital Input/Output

3.4.11. RS-232 Port

The RS-232 port (if present) has the following specification:

| Feature | Specification |
|---------------------------------|--|
| Protocol | 3-wire RS-232: GND, TXD, RXD |
| Baud rate | 300, 1 200, 2 400, 4 800, 9 600, 19 200, 38 400, 57 600, 115 200 , 230 400, 460 800 |
| Data bits | 7 bit, 8 bit |
| Parity | none , odd, even |
| Stop bits | 1 , 2 |
| Software flow control | none , XON/XOFF |
| Hardware flow control | none |
| Galvanic isolation to enclosure | none |
| Max. cable length | 10 m |
| Cable shield | mandatory |

Table 3.24.: Non-isolated RS-232 Port Specification

Pin Assignment M12, 4 poles, D-coded female

| Pin | Signal | Pinning |
|-----|---------------|---|
| 1 | GND |  |
| 2 | RxD | |
| 3 | not connected | |
| 4 | TxD | |

Table 3.25.: Pin Assignments of RS-232 Port

4. Installation

The NB3700 is designed for mounting it on a worktop or wall. Please consider the safety instructions in chapter 2 and the environmental conditions in chapter 3.3.

The following precautions must be taken before installing a NB3700 router:

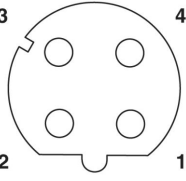
- Avoid direct solar radiation
- Protect the device from humidity, steam and aggressive fluids
- Guarantee sufficient circulation of air around the device
- The device is for indoor use only



Attention: NetModule routers are not intended for the end consumer market. The device must be installed and commissioned by a certified expert.

4.1. Installation of the Mini-SIM Cards

Up to two Mini-SIM cards can be inserted in a NB3700 router.

SIM cards can be inserted by sliding it into one of the designated slots on the front panel. You have to push the SIM card using a small paper clip (or similar) until it snaps into place. To remove the SIM, you will need to push it again in the same manner. The SIM card will then rebound and can be pulled out.

SIMs can be assigned flexibly to any modem in the system. It is also possible to switch a SIM to a different modem during operation, for instance if you want to use another provider upon a certain condition. However, a SIM switch usually takes about 10-20 seconds which can be bypassed (e.g. at bootup) if SIMs are installed reasonably. Using only a single SIM with one modem, it should be preferably placed into the SIM 1 holder. For systems which should operate two modems with two SIMs in parallel, we recommend to assign **Mob 1** to SIM 1 and **Mob 2** to SIM 2.

Further information about SIM configuration can be found in chapter 5.3.3.



Attention: After a SIM Switch the SIM Cover of the NB3700 router has to be mounted again and screwed to get IP40 protection class.

4.2. Installation of the GSM/UMTS/LTE Antenna

NetModule routers will only operate efficiently in the cellular network if there is a good signal. A stub antenna will be suitable for most applications. However, in some circumstances it might be necessary to use remote antennas together with an extended cable to reach a

better location offering an adequate signal. In doubt, please contact us and we would be pleased to assist you in figuring out the best matching antenna setup for your application. Keep in mind that effects caused by Faraday cages such as large metal surfaces (elevators, machine housings, etc.), close meshed iron constructions and others may reduce signal reception significantly.

The mounted antennas or antenna cables should be fixed with a wrench.

The following table shows how to connect the LTE/UMTS antennas. Generally, LTE antennas use both, main and auxiliary ports, but UMTS requires only main ports.

| Antenna Port | Type |
|--------------|-----------|
| Mob 1 | Main |
| Mob 2 | Auxiliary |

Table 4.1.: LTE/UMTS antenna port types



Attention: Following points must be observed when installing the antennas:

- A minimum clearance of at least 40 cm between people and the antennas must always be ensured.
- If one mobile interface transmit simultaneously with other collocated radio transmitters the separation distance of 20 cm between the antennas must be maintained at all times.
- Antennas which are installed outside a building or the vehicle hull must limit transient overvoltages (according to IEC 62368-1) to below a peak of 1500 V through external protection circuits.
- Mobile communications antennas may have an amplification of maximum 2.5dBi, including the cable attenuation, in the relevant frequency range.

4.3. Installation of the WLAN Antennas

The following table shows how to connect the WLAN antennas. The number of attached antennas can be configured in the software. If only one antenna is used, it must be attached to the main port. However, for better diversity and thus better throughput and coverage, we highly recommend using two antennas.

| Antenna Port | Type |
|---------------|-----------|
| WLAN 1 | Main |
| WLAN 2 | Auxiliary |

Table 4.2.: WLAN antenna port types



- Attention:** Following points must be observed when installing the antennas:
- A minimum clearance of at least 40 cm between people and the antennas must always be ensured.
 - If one WLAN interface transmit simultaneously with other collocated radio transmitters the separation distance of 20 cm between the antennas must be maintained at all times.
 - WLAN antennas must only be installed in buildings or within vehicle hulls.
 - WLAN antennas may have an amplification of maximum 3dBi in the relevant frequency range. WLAN antennas with a higher amplification may be used with the NetModule router "Enhanced-RF-Configuration" software license and the antenna gain and cable attenuation that have been correctly configured by certified specialized personnel.

4.4. Installation of the GPS Antenna

The GNSS antenna must be mounted to the connector **GPS**. Whether the antenna is an active or passive GPS antenna has to be configured in the software. We recommend active GPS antennas for highly accurate GPS tracking.



- Attention:** Following points must be observed when installing the antenna:
- A minimum clearance of at least 40 cm between people and the antenna must always be ensured.
 - Antennas which are installed outside a building or the vehicle hull must limit transient overvoltages (according to IEC 62368-1) to below a peak of 1500 V through external protection circuits.

4.5. Installation of the Local Area Network

Up to five 10/100 Mbps Ethernet devices can be directly connected to the router, further devices can be attached via an additional Ethernet switch. Please ensure that the connector has been plugged in properly and remains in a fixed state, you might otherwise experience sporadic link loss during operation. The Link/Act LED will lit up as soon as the device has synced. If not, it might be necessary to configure a different link setting as described in chapter 5.3.2. By default, the router is configured as a DHCP server and has the IP address 192.168.1.1.



Attention:

Only a shielded Ethernet cable may be used.

4.6. Installation of the Power Supply

The router can be powered with an external source supplying between 12 V_{DC} and 48 V_{DC} or 50 V_{DC} and 136 V_{DC} respectively. It is to be used with a certified (CE or equivalent) power supply, which must have a limited and SELV circuit output. The router is now ready for getting engaged.



Attention: Only CE-compliant power supplies with a current-limited SELV output voltage range (for NetModule routers with "Pb" option with a correspondingly higher output voltage range and in accordance with appropriate comparable safety precautions) may be used with the NetModule routers

5. Configuration

The following chapters give information about setting up the router and configuring its features as provided with system software 4.1.



NetModule provides regularly updated router software with new functions, bug fixes and closed vulnerabilities. Please keep your router software up to date.

<ftp://share.netmodule.com/router/public/system-software/>

5.1. First Steps

NetModule routers can be easily set up by using the HTTP-based configuration interface, called the Web Manager. It is supported by the latest web browsers (e.g. Microsoft Internet Explorer 11, Mozilla Firefox 28.0, Safari 7 and many others). Please ensure to have JavaScript turned on.

Any submitted configuration via the Web Manager will be applied immediately to the system when pressing the `Apply` button. When configuring subsystems which require multiple steps (for instance WLAN) you can use the `Continue` button to store any settings temporarily and apply them at a later time. Please note, that those settings will be neglected at logout unless applied.

You may also upload configuration files via SNMP, SSH, HTTP or USB in case you intend to deploy a larger numbers of routers. Advanced users may also use the Command Line Interface (CLI) and set configuration parameters directly.

The IP address of Ethernet1 is 192.168.1.1 and the Dynamic Host Configuration Protocol (DHCP) is activated on the interface by default. The following steps need to be taken to establish your first Web Manager session:

1. Connect the Ethernet port of your computer to the Ethernet 1 (FastEthernet) port of the router using a shielded CAT5 cable with RJ45 (or M12) connector.
2. If not yet activated, enable DHCP on your computer's Ethernet interface so that an IP address can be obtained automatically from the router. This usually takes a short amount of time until your PC has received the corresponding parameters (IP address, subnet mask, default gateway, name server). You may track the progress by having a look to your network control panel and check whether your PC has correctly retrieved an IP address of the range 192.168.1.100 to 192.168.1.199.
3. Launch your favorite web browser and point it to the IP address of the router (the URL is <http://192.168.1.1>).
4. Please follow the instructions of the Web Manager for configuring the router. Most of the menus are self-explanatory, further details are given in the following chapters.

5.1.1. Initial Access

In factory state you will be prompted for a new administrator password. Please choose a password which is both, easy to remember but also robust against dictionary attacks (such

as one that contains numbers, letters and punctuation characters). The password shall have a minimum length of 6 characters. It shall contain a minimum of 2 numbers and 2 letters.

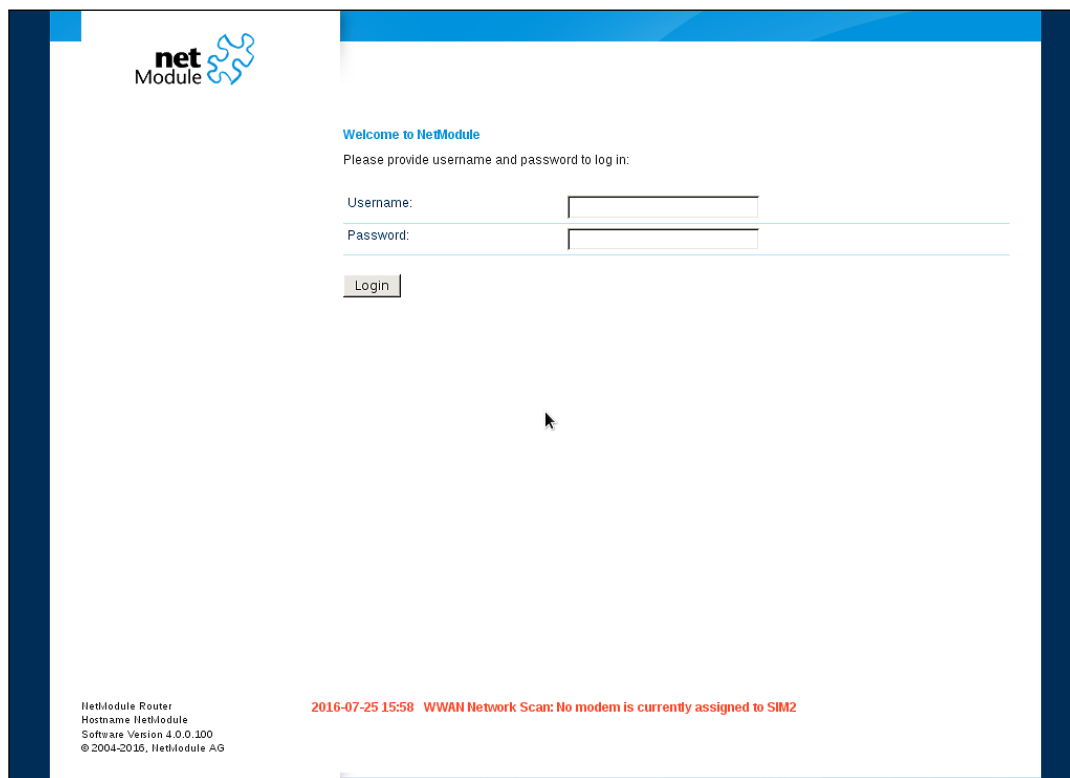

Figure 5.1.: Initial Login

Please note that the admin password will be also applied for the root user which can be used to access the device via the serial console, telnet, SSH or to enter the bootloader. You may also configure additional users which will only be granted to access the summary page or retrieve status information but not to set any configuration parameters.

A set of services (USB Autorun, CLI-PHP) are by default activated in factory state and will be disabled as soon as the admin password has been set. They can be enabled again afterwards in the relevant sections. Other services (SSH, Telnet, Console) can be accessed in factory state by providing an empty or no password.

5.1.2. Recovery

Following actions might be taken in case the router has been misconfigured and cannot be reached anymore:

1. **Factory Reset:** You can initiate a reset back to factory settings via the Web Manager, by running the command `factory-reset` or by pressing the reset button. The latter would require a slim needle or paper clip which must be inserted into the hole to the left of the SIM 1 slot. The button must be hold pressed for up to 5 seconds until all LEDs flash up.
2. **Serial Console Login:** It is also possible to log into the system via the serial port. This

would require a terminal emulator (such as PuTTY or HyperTerminal) and an RS232 connection (115200 8N1) attached to the serial port of your local computer. You will also see the kernel messages at bootup there.

3. Recovery Image: In severe cases we can provide a recovery image on demand which can be loaded into RAM via TFTP and executed. It offers a minimal system image for running a software update or doing other modifications. You will be provided with two files, `recovery-image` and `recovery-dtb`, which must be placed in the root directory of a TFTP server (connected via LAN1 and address 192.168.1.254). The recovery image can be launched from the boot-loader using a serial connection. You will have to stop the boot process by pressing `s` and enter the bootloader. You can then issue `run recovery` to load the image and start the system which can be accessed via HTTP/SSH/Telnet and its IP address 192.168.1.1 afterwards. This procedure can be also initiated by holding the factory reset button longer than 15 seconds.

5.2. HOME

This page provides a status overview of enabled features and connections.

The screenshot shows the NetModule WEB MANAGER interface. The top navigation bar includes: HOME, INTERFACES, ROUTING, FIREWALL, VPN, SERVICES, SYSTEM, and LOGOUT. The left sidebar is labeled 'WEB MANAGER' and lists various status categories: Summary, WAN, WWAN, WLAN, GNSS, Ethernet, LAN, DHCP, OpenVPN, IPsec, MobileIP, Firewall, QoS, and System. The main content area is titled 'Summary' and contains a table with the following data:

| Description | Administrative Status | Operational Status |
|-------------|-----------------------|--------------------|
| Hotlink | | WWAN1 |
| WWAN1 | enabled | up |
| WWAN2 | enabled | up |
| WLAN1 | enabled, access-point | up |
| GNSS | enabled | up |
| OpenVPN1 | enabled, server | up |
| MobileIP | enabled | down |

At the bottom left of the page, the following information is displayed:

```

NetModule Router
Hostname NetModule
Software Version 4.0.0.100
© 2004-2016, NetModule AG

```

Figure 5.2.: Home

Summary

This page offers a short summary about the administrative and operational status of the router's interfaces.

WAN

This page offers details about any enabled Wide Area Network (WAN) links (such as the IP addresses, network information, signal strength, etc.) The information about the amount of downloaded/uploaded data is stored in non-volatile memory, thus survive a reboot of the system.

The counters can be reset by pressing the *Reset* button.

WWAN

This page shows information about modems and their network status.

WLAN

The WLAN page offers details about the enabled WLAN interfaces when operating in access-point mode. This includes the SSID, IP and MAC address and the currently used frequency and transmit power of the interface as well as the list of associated stations.

GNSS

This page displays the position status values, such as latitude/longitude, the satellites in view and more details about the used satellites.

Ethernet

This page shows information about the Ethernet interfaces and packet statistics information.

LAN

This page shows information about the LAN interfaces plus the neighborhood information.

DHCP

This page offers details about any activated DHCP service, including a list of issued DHCP leases.

OpenVPN

This page provides information about the OpenVPN tunnel status.

IPSec

This page provides information about the IPsec tunnel status.

PPTP

This page provides information about the PPTP tunnel status.

GRE

This page provides information about the GRE tunnel status.

MobileIP

This page provides information about Mobile IP connections.

Firewall

This page offers information about any firewall rules and their matching statistics. It can be used to debug the firewall.

QoS

This page provides information about the used QoS queues.

BGP

This page provides information about the Border Gateway Protocol.

OSPF

This page provides information about the Open Shortest Path First routing protocol.

DynDNS

This page provides information about Dynamic DNS.

System Status

The system status page displays various details of your NB3700 router, including system details, information about mounted modules and software release information.

SDK

This section will list all webpages generated by SDK scripts.

5.3. INTERFACES

5.3.1. WAN

Link Management

Depending on your hardware model, WAN links can be made up of either Wireless Wide Area Network (WWAN), Wireless LAN (WLAN), Ethernet or PPP over Ethernet (PPPoE) connections. Please note that each WAN link has to be configured and enabled in order to appear on this page.

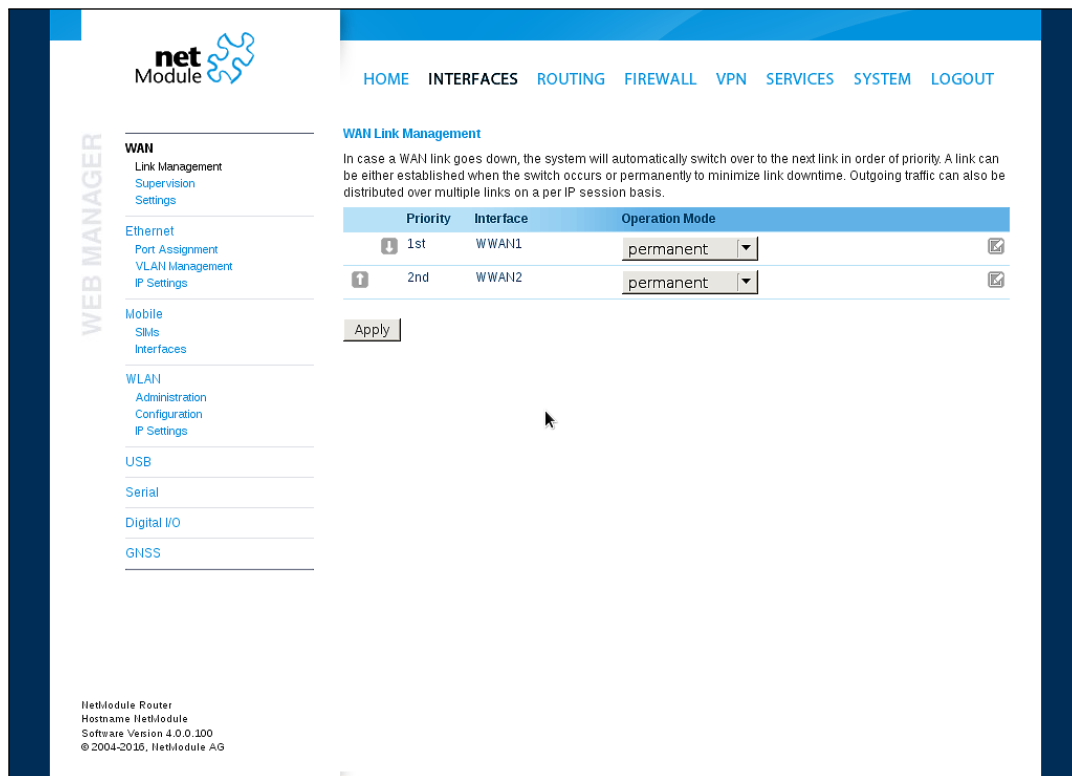

Figure 5.3.: WAN Links

In general, a link will be only dialed or declared as up if the following prerequisites are met:

| Condition | WWAN | WLAN | ETH | PPPoE |
|------------------------------------|------|------|-----|-------|
| Modem is registered | X | | | |
| Registered with valid service type | X | | | |
| Valid SIM state | X | | | |
| Sufficient signal strength | X | X | | |
| Client is associated | | X | | |
| Client is authenticated | | X | | |
| Valid DHCP address retrieved | X | X | X | X |
| Link is up and holds address | X | X | X | X |
| Ping check succeeded | X | X | X | X |

The menu can be used further to prioritize your WAN links. The highest priority link which has been established successfully will become the so-called `hotlink` which holds the default route for outgoing packets.

In case a link goes down, the system will automatically switch over to the next link in the priority list. You can configure each link to be either established when the switch occurs or permanently in order to minimize link downtime.

| Parameter | WAN Link Priorities |
|--------------|--|
| 1st priority | The primary link which will be used whenever possible. |
| 2nd priority | The first fallback link, it can be enabled permanently or being dialed as soon as Link 1 goes down. |
| 3rd priority | The second fallback link, it can be enabled permanently or being dialed as soon as Link 2 goes down. |
| 4th priority | The third fallback link, it can be enabled permanently or being dialed as soon as Link 3 goes down. |

Links are being triggered periodically and put to sleep in case it was not possible to establish them within a certain amount of time. Hence it might happen that permanent links will be dialed in background and replace links with lower priority again as soon as they got established. In case of interfering links sharing the same resources (for instance in dual-SIM operation) you may define a switch-back interval after which an active hotlink is forced to go down in order to let the higher-prio link getting dialed again.

We recommend to use the `permanent` operation mode for WAN links in general. However, in case of time-limited mobile tariffs for instance, the `switchover` mode might be applicable. By using the `distributed` mode, it is possible to distribute outgoing traffic over multiple WAN links based on their weight ratio.

**Attention:**

You can have concurrent WWAN links which share a common resource like one WWAN module using SIM cards of different providers. In that case it would not be possible to find out if the link with the higher priority is available without putting down the low priority link. Therefore such a link will behave like a switchover even if configured as permanent.

For mobile links, it is further possible to pass through the WAN address towards a local host (also called Drop-In or IP Pass-through). In particular, the first DHCP client will receive the public IP address. More or less, the system acts like a modem in such case which can be helpful in case of firewall issues. Once established, the Web Manager can be reached over port 8080 using the WAN address but still over the LAN1 interface using port 80.

| Parameter | WAN Link Operation Modes |
|---------------|--|
| disabled | Link is disabled |
| permanent | Link is being established permanently |
| on switchover | Link is being established on switchover, it will be dialled if previous links failed |
| distributed | Link is member of a load distribution group |

| Parameter | WAN Link Settings |
|---------------------------------|---|
| Operation mode | The operation mode of the link |
| Weight | The weight ratio of a distributed link |
| Switch-back | Specifies the switch-back condition of a switchover link and the time after an active hotlink will be teared down |
| Bridging interface ¹ | If WLAN client, the LAN interface to which the WAN link should be bridged. |

NetModule routers provide a feature called IP pass-through (aka Drop-In mode). If enabled, the WAN address will be passed-through to the first DHCP client of the specified LAN interface. As Ethernet-based communication requires additional addresses, we pick an appropriate subnet to talk to the LAN host. In case this overlaps with other addresses of your WAN network, you may optionally specify the network given by your provider to avoid any address conflicts.

| Parameter | IP Pass-Through Settings |
|-----------------|-------------------------------------|
| IP Pass-through | Enables or disables IP pass-through |

¹This options requires an Access Point with four address frame format support.

| Parameter | IP Pass-Through Settings |
|-------------|--|
| Interface | Specifies the interface on which the address shall be passed-through |
| WAN network | Specifies the WAN network |
| WAN netmask | Specifies the WAN netmask |

WAN Settings

This page can be used to configure WAN specific settings like the Maximum Segment Size (MSS). The MSS corresponds to the largest amount of data (in bytes) that the router can handle in a single, unfragmented TCP segment. In order to avoid any negative side effects the number of bytes in the data segment and the headers must not add up to more than the number of bytes in the Maximum Transmission Unit (MTU). The MTU can be configured per each interface and corresponds to the largest packet size that can be transmitted.

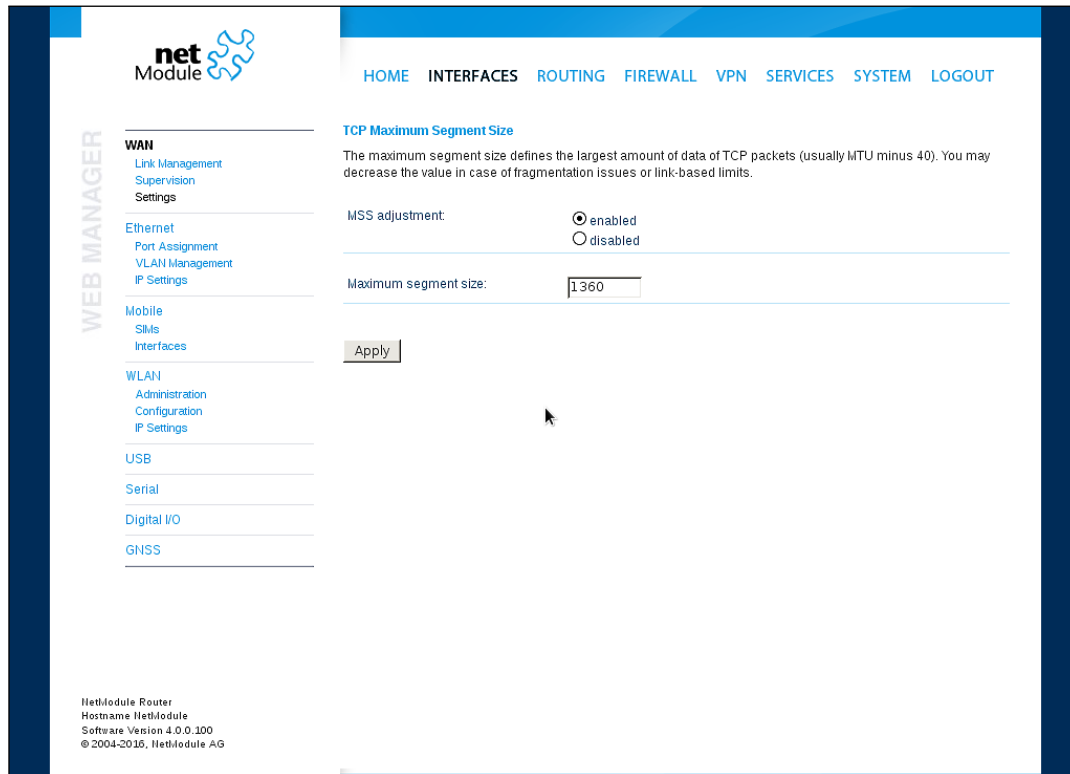

Figure 5.4.: WAN Settings

| Parameter | TCP MSS Settings |
|----------------------|---|
| MSS adjustment | Enable or disable MSS adjustment on WAN interfaces. |
| Maximum segment size | Maximum number of bytes in a TCP data segment. |

Supervision

Network outage detection on a per-link basis can be performed by sending pings on each link to some authoritative hosts. A link will be declared as down in case all trials have failed and only as up if at least one host can be reached.

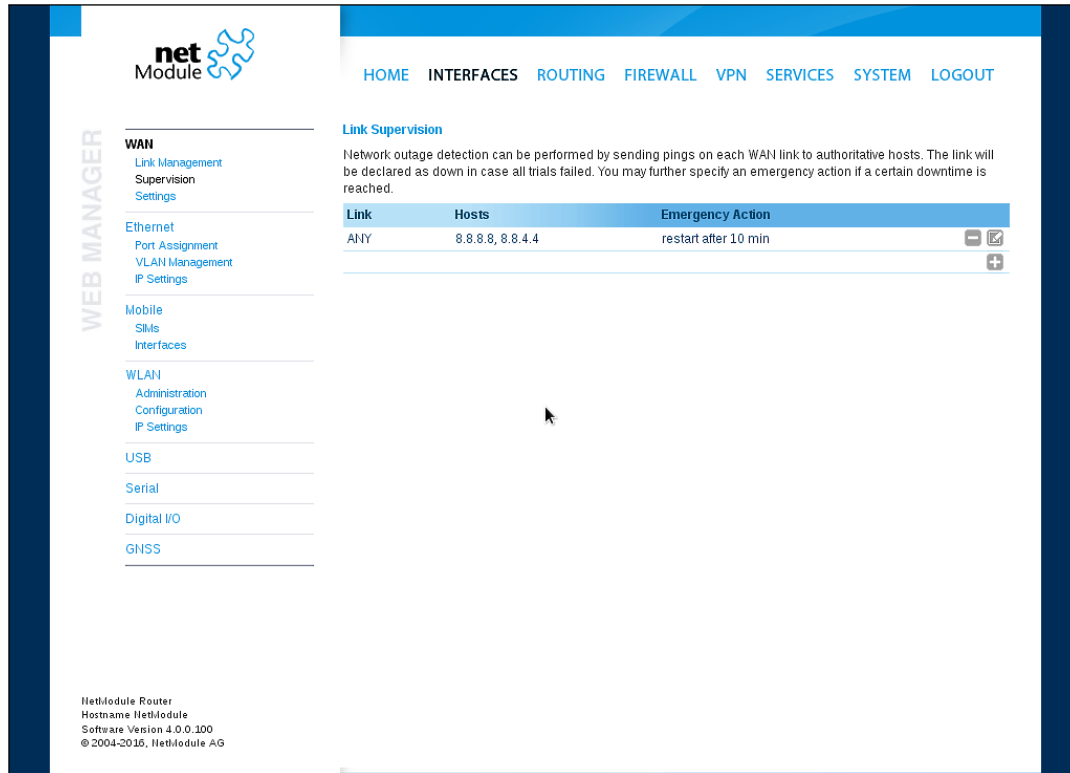

Figure 5.5.: Link Supervision

| Parameter | Supervision Settings |
|----------------|---|
| Link | The WAN link to be monitored (can be ANY) |
| Mode | Specifies whether the link shall only be monitored if being up (e.g. for using a VPN tunnel) or if connectivity shall be also validated at connection establishment (default) |
| Primary host | The primary host to be monitored |
| Secondary host | The secondary host to be monitored (optional) |
| Ping timeout | The amount of time in milliseconds a response for a single ping can take, consider to increase this value in case of slow and tardy links (such as 2G connections) |
| Ping interval | The interval in seconds at which pings are transmitted on each interface |

| Parameter | Supervision Settings |
|------------------------------|---|
| Retry interval | The interval in seconds at which pings are re-transmitted in case a first ping failed |
| Max. number of failed trials | The maximum number of failed ping trials until the link will be declared as down |
| Emergency action | The emergency action which should be taken after a maximum downtime has been reached. Using <code>reboot</code> would perform a reboot of the system, <code>restart link services</code> will restart all link-related applications including a reset of the modem. |

5.3.2. Ethernet

NB3700 routers ship with an Ethernet switch (ETH1-ETH5) which can be linked via M12 connectors.

ETH1 usually forms the LAN1 interface which should be used for LAN purposes. Other interfaces can be used to connect other LAN segments or for configuring a WAN link. The LAN10 interface will be available as soon as a pre-configured USB Ethernet device has been plugged in.

Ethernet Port Assignment

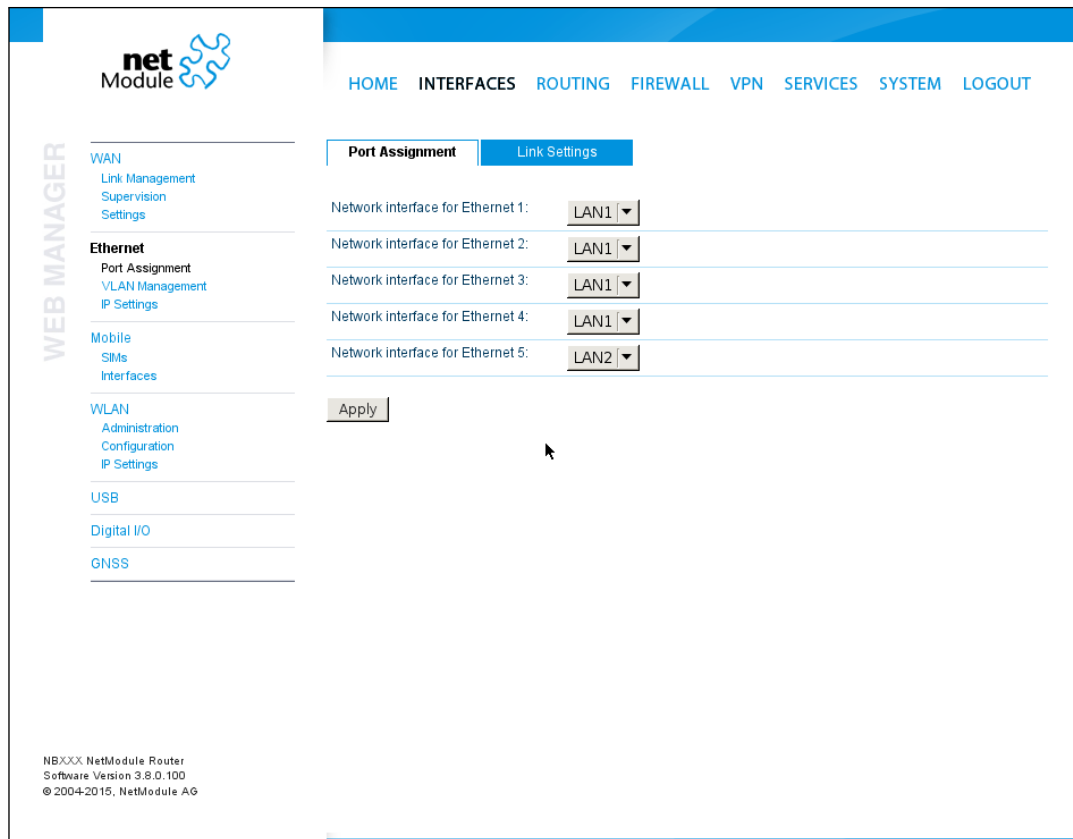

Figure 5.6.: Ethernet Ports

This menu can be used to individually assign each Ethernet port to a LAN interface, just in case you want to have different subnets per port or use one port as WAN interface. You may assign multiple ports to the same interface.

Ethernet Link Settings

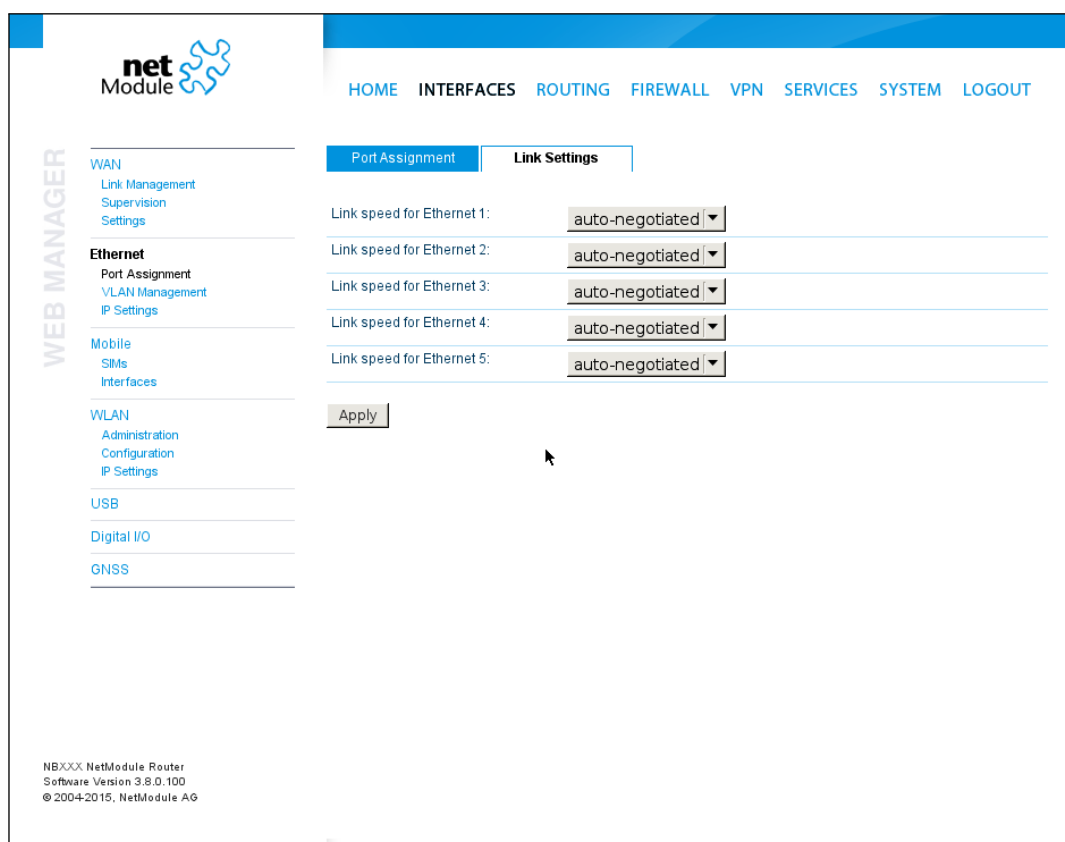

Figure 5.7.: Ethernet Link Settings

Link negotiation can be set for each Ethernet port individually. Most devices support auto-negotiation which will configure the link speed automatically to comply with other devices in the network. In case of negotiation problems, you may assign the modes manually but it has to be ensured that all devices in the network utilize the same settings then.

VLAN Management

NetModule routers support Virtual LAN according to IEEE 802.1Q which can be used to create virtual interfaces on top of an Ethernet interface. The VLAN protocol inserts an additional header to Ethernet frames carrying a VLAN Identifier (VLAN ID) which is used for distributing the packets to the associated virtual interface. Any untagged packets, as well as packets with an unassigned ID, will be distributed to the native interface.

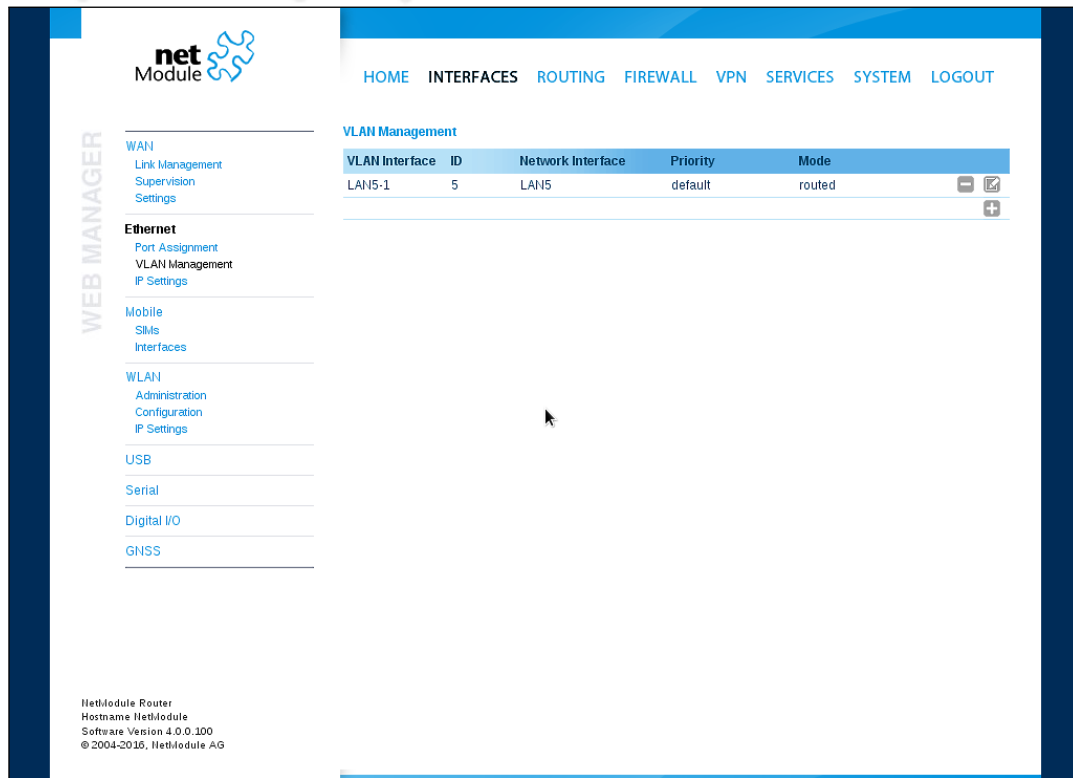

Figure 5.8.: VLAN Management

In order to form a distinctive subnet, the network interface of a remote LAN host must be configured with the same VLAN ID as defined on the router. Further, 802.1P introduces a priority field which influences packet scheduling in the TCP/IP stack.

The following priority levels (from lowest to highest) exist:

| Parameter | VLAN Priority Levels |
|-----------|-------------------------------------|
| 0 | Background |
| 1 | Best Effort |
| 2 | Excellent Effort |
| 3 | Critical Applications |
| 4 | Video (< 100 ms latency and jitter) |
| 5 | Voice (< 10 ms latency and jitter) |
| 6 | Internetwork Control |
| 7 | Network Control |

IP Settings

This page can be used to configure IP addressing for your LAN/WAN Ethernet interfaces. In addition to the primary IP address/subnet mask you may define an additional IP address alias on the interface.

Please keep in mind that the DNS servers can be set globally in the DNS server configuration menu. But as soon as a link comes up it will use the interface-specific name-servers (e.g. the ones being retrieved over DHCP) and update the resolver configuration accordingly.

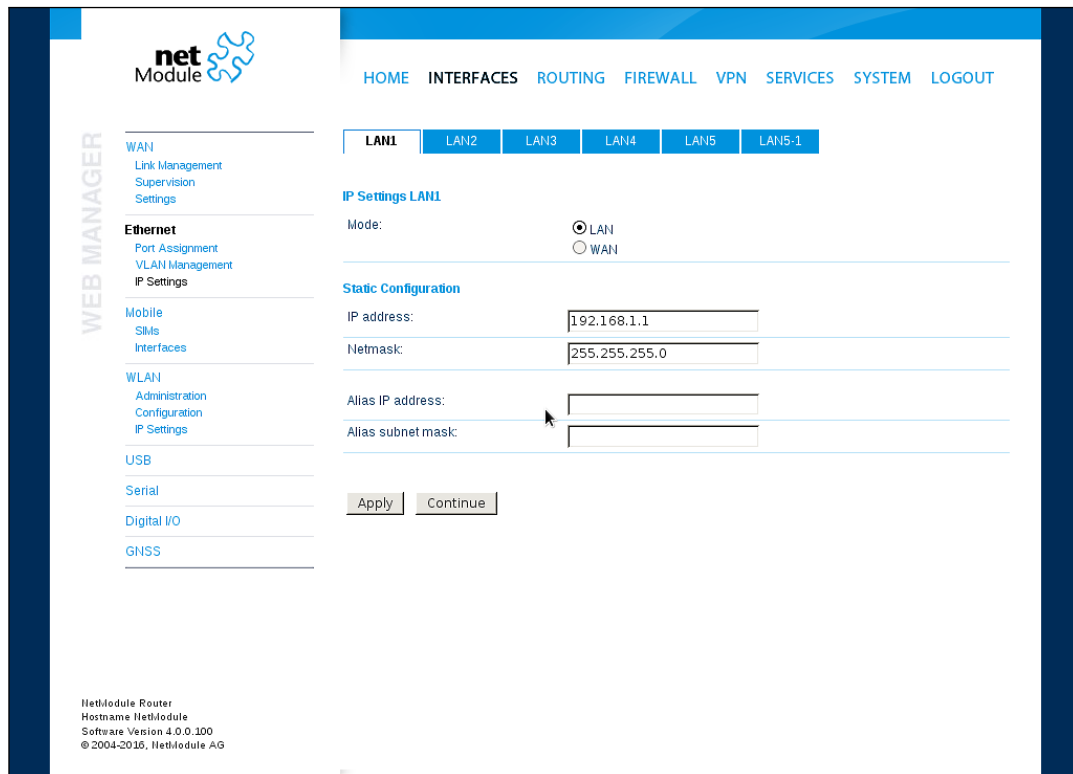

Figure 5.9.: LAN IP Configuration

| Parameter | LAN IP Settings |
|-----------|--|
| Mode | Defines whether this interface is being used as LAN or WAN interface |

When running in LAN mode, the interface may be configured with the following settings:

| Parameter | LAN IP Settings |
|-------------------|--|
| IP address | The IP interface address |
| Subnet mask | The subnet mask for this interface |
| Alias IP address | The alias IP interface address |
| Alias subnet mask | The alias subnet mask for this interface |

When running in WAN mode, the interface may be configured with the following settings:

| Parameter | WAN IP Settings |
|-----------|---|
| WAN mode | The WAN operation mode, defines whether the interface should run as DHCP client, statically configured or over PPPoE. |
| MTU | The Maximum Transmission Unit for the interface, if provided it will specify the largest size of a packet transmitted on the interface. |

When running as DHCP client, no further configuration is required because all IP-related settings (address, subnet, gateway, DNS server) will be retrieved from a DHCP server in the network. You may also define static values but caution has to be taken to assign a unique IP address as it would otherwise raise IP conflicts in the network.

PPPoE is commonly used when communicating with another WAN access device (like a DSL modem). The following settings can be applied:

| Parameter | PPPoE Configuration |
|--------------------------|--|
| User name | PPPoE user name for authenticating at the access device |
| Password | PPPoE password for authenticating at the access device |
| Service name | Specifies the service name set of the access concentrator and can be left blank unless you have multiple services on the same physical network and need to specify the one you want to connect to. |
| Access concentrator name | The name of the concentrator (the PPPoE client will connect to any access concentrator if left blank) |

5.3.3. Mobile

Modems Configuration

This page lists all available WWAN modems. They can be disabled on demand.

Query

This page allows you to send Hayes AT commands to the modem. Besides the 3GPP-conforming AT command-set further modem-specific commands can be applicable which we can provide on demand. Some modems also support running Unstructured Supplementary Service Data (USSD) requests, e.g. for querying the available balance of a prepaid account.

SIMs

The screenshot shows the 'SIM Cards' configuration page in the NetModule web interface. The page includes a navigation menu on the left and a main content area with a table of SIM cards. Below the table is an 'Update' button.

| SIM | Default | Current | State | PIN Protection | Registered |
|------|---------|---------|------------|----------------|------------|
| SIM1 | Mobile1 | Mobile2 | ready | disabled | yes |
| SIM2 | Mobile2 | Mobile1 | ready | disabled | yes |
| SIM3 | none | none | unassigned | unknown | no |
| SIM4 | none | none | unassigned | unknown | no |

Figure 5.10.: SIMs

The SIM page gives an overview about the available SIM cards, their assigned modems and the current state. Once a SIM card has been inserted, assigned to a modem and successfully unlocked, the card should remain in state `ready` and the network registration status should have turned to `registered`. If not, please double-check your PIN.

Please keep in mind that registering to a network usually takes some time and depends on signal strength and possible radio interferences. You may hit the `Update` button at any time in order to restart PIN unlocking and trigger another network registration attempt.

Under some circumstances (e.g. in case the modem flaps between base stations) it might be necessary to set a specific service type or assign a fixed operator. The list of operators around can be obtained by initiating a network scan (may take up to 60 seconds). Further details can be retrieved by querying the modem directly, a set of suitable commands can be provided on request.

Configuration

A SIM card is generally assigned to a default modem but might be switched, for instance if you set up two WWAN interfaces with one modem but different SIM cards.

Close attention has to be paid when other services (such as SMS or Voice) are operating on that modem, as a SIM switch will naturally affect their operation.

The following settings can be applied:

| Parameter | WWAN SIM Configuration |
|-------------------|--|
| PIN code | The PIN code for unlocking the SIM card |
| PUK code | The PUK code for unlocking the SIM card (optional) |
| Default modem | The default modem assigned to this SIM card |
| Preferred service | The preferred service to be used with this SIM card. Remember that the link manager might change this in case of different settings. The default is to use <code>automatic</code> , in areas with interfering base stations you can force a specific type (e.g. 3G-only) in order to prevent any flapping between the stations around. |
| Registration mode | The desired registration mode |
| Network selection | Defines which network shall be selected. This can be bound to a specific LAI which can be retrieved by running a network scan. |

WWAN Interfaces

This page can be used to manage your WWAN interfaces. The resulting link will pop up automatically as WAN link once an interface has been added. Please refer to chapter 5.3.1 for how to manage them.

The Mobile LED will be blinking during the connection establishment process and goes on as soon as the connection is up. Refer to section 5.8.7 or consult the system log files for troubleshooting the problem in case the connection did not come up.

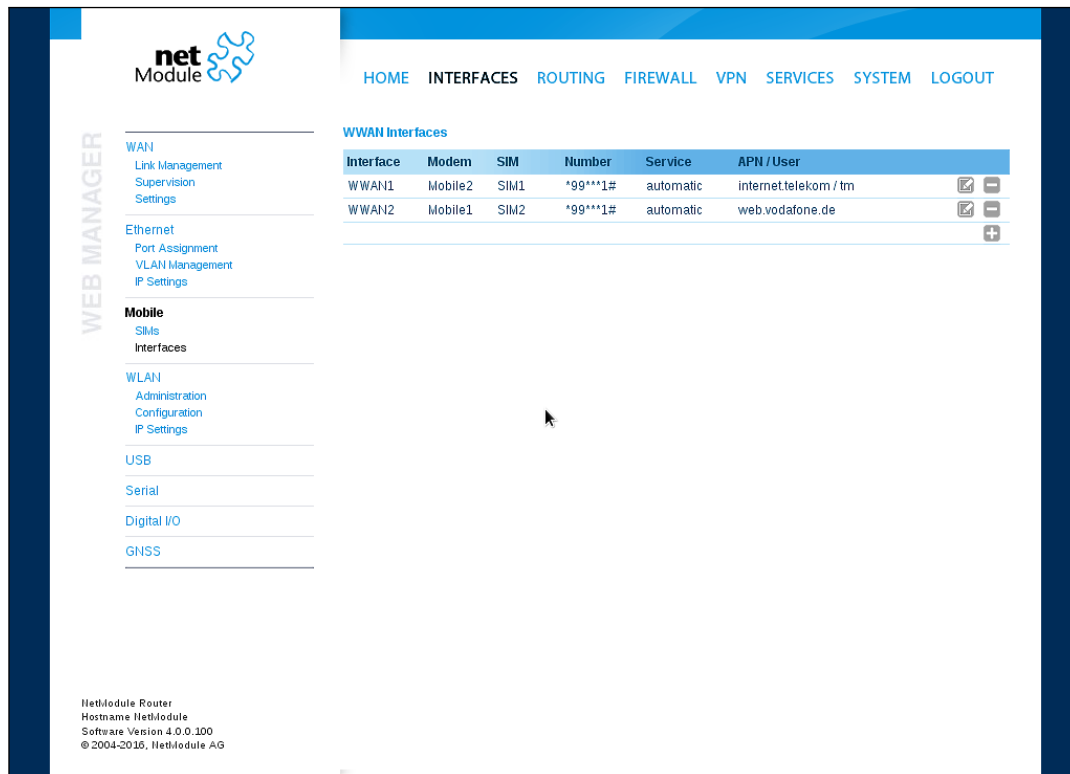

Figure 5.11.: WWAN Interfaces

The following mobile settings are required:

| Parameter | WWAN Mobile Parameters |
|--------------|---|
| Modem | The modem to be used for this WWAN interface |
| SIM | The SIM card to be used for this WWAN interface |
| Service type | The required service type |

Please note that these settings supersede the general SIM based settings as soon as the link is being dialed.

Generally, the connection settings are derived automatically as soon as the modem has registered and the network provider has been found in our database. Otherwise, it will be required to configure the following settings manually:

| Parameter | WWAN Connection Parameters |
|-------------------|---|
| Phone number | The phone number to be dialed, for 3G+ connections this commonly refers to be *99***1#. For circuit-switched 2G connections you can enter the fixed phone number to be dialed in international format (e.g. +41xx). |
| Access point name | The access point name (APN) being used |
| Authentication | The authentication scheme being used, if required this can be PAP or/and CHAP |
| Username | The user-name used for authentication |
| Password | The password used for authentication |

Furtheron, you may configure the following advanced settings:

| Parameter | WAN Advanced Parameters |
|--------------------------|--|
| Required signal strength | Sets a minimum required signal strength before the connection is dialed |
| Home network only | Determines whether the connection should only be dialed when registered to a home network |
| Negotiate DNS | Specifies whether the DNS negotiation should be performed and the retrieved name-servers should be applied to the system |
| Call to ISDN | Has to be enabled in case of 2G connections talking to an ISDN modem |
| Header compression | Enables or disables 3GPP header compression which may improve TCP/IP performance over slow serial links. Has to be supported by your provider. |
| Data compression | Enables or disables 3GPP data compression which shrinks the size of packets to improve throughput. Has to be supported by your provider. |
| Client address | Specifies a fixed client IP address if assigned by the provider |
| MTU | The Maximum Transmission Unit for this interface |

5.3.4. WLAN

WLAN Management

In case your router is shipping with a WLAN (or Wi-Fi) module you can operate it either as client, access point or managed mode. As a client it can create an additional WAN link which for instance can be used as backup link. As access point, it can form another LAN interface which can be either bridged to an Ethernet-based LAN interface or create a self-contained IP interface which can be used for routing and to provide services (such as DHCP/DNS/NTP) in the same way like an Ethernet LAN interface does.

The screenshot displays the NetModule web interface for WLAN Management. The top navigation bar includes links for HOME, INTERFACES, ROUTING, FIREWALL, VPN, SERVICES, SYSTEM, and LOGOUT. The left sidebar, labeled 'WEB MANAGER', lists various configuration categories: WAN (Link Management, Supervision, Settings), Ethernet (Port Assignment, VLAN Management, IP Settings), Mobile (SIMs, Interfaces), WLAN (Administration, Configuration, IP Settings), USB, Serial, Digital I/O, and GNSS. The main content area is titled 'WLAN Management' and contains the following configuration fields:

- Administrative status:** Radio buttons for enabled and disabled.
- Operational mode:** Radio buttons for client, access point, and managed.
- Regulatory domain:** A dropdown menu set to 'Germany'.
- Number of antennas:** A dropdown menu set to '1'.
- Antenna gain:** A text input field set to '0' dB.
- Operation type:** A dropdown menu set to '802.11b'.
- Radio band:** A dropdown menu set to '2.4 GHz'.
- Bandwidth:** A dropdown menu set to '20 MHz'.
- Channel:** A dropdown menu set to '1 (2412 MHz)', with a link for 'Channel utilisation'.

At the bottom of the configuration area, there are 'Apply' and 'Continue' buttons. The footer of the interface shows: 'NetModule Router', 'Hostname NetModule', 'Software Version 4.0.0.100', and '© 2004-2016, NetModule AG'.

Figure 5.12.: WLAN Management

If the administrative status is set to `disabled`, the module will be powered off in order to reduce the overall power consumption. Regarding antennas, we generally recommend using two antennas for better coverage and throughput. A second antenna is definitely mandatory if you want to achieve higher throughput rates as in 802.11n.

A WLAN `client` will automatically become a WAN link and can be managed as described in chapter 5.3.1.

Configurable parameters for access-point and client mode:

| Parameter | WLAN Management |
|--------------------|---|
| Regulatory Domain | Select the country the Router operates in |
| Number of antennas | Set the number of connected antennas |
| Antenna gain | Specify the antenna gain for the connected antennas. Please refer to the antennas datasheet for the correct gain value. |



Warning

Please be aware that any inappropriate parameters can lead to an infringement of conformity regulations.

Running as access point, you can further configure the following settings:

| Parameter | WLAN Management |
|----------------|--|
| Operation type | Specifies the desired IEEE 802.11 operation mode |
| Radio band | Selects the radio band to be used for connections, depending on your module it could be 2.4 or 5 GHz |
| Bandwidth | Specify the channel bandwidth operation mode |
| Channel | Specifies the channel to be used |

Running as client, you can further configure the following settings:

| Parameter | WLAN Management |
|---------------|--|
| Scan channels | Select if all supported channels should be scanned or just user defined channels |
| 2.4 GHz | Set the channels which should be scanned in 2.4 GHz |
| 5 GHz | Set the channels which should be scanned in 5 GHz |

Available operation modes are:

| Standard | Frequencies | Bandwidth | Data Rate |
|----------|-------------|-----------|-----------|
| 802.11a | 5 GHz | 20 MHz | 54 Mbit/s |
| 802.11b | 2.4 GHz | 20 MHz | 11 Mbit/s |

| Standard | Frequencies | Bandwidth | Data Rate |
|-----------------------|-------------|--------------|--------------|
| 802.11g | 2.4 GHz | 20 MHz | 54 Mbit/s |
| 802.11n | 2.4/5 GHz | 20/40 MHz | 300 Mbit/s |
| 802.11ac ² | 5 GHz | 20/40/80 MHz | 866.7 Mbit/s |

Table 5.20.: IEEE 802.11 Network Standards

Note: NetModule Routers with 802.11n and 802.11ac support 2x2 MIMO

²Only available for NetModule Routers NB2800, NB3701, NB3711 and NB3800

Prior to setting up an access point, it is always a good idea to run a network scan for getting a list of neighboring WLAN networks and then choose the less interfering channel. Please note that two adequate channels are required for getting good throughputs with 802.11n and a bandwidth of 40 MHz.

Running in `managed` mode, the access-point can be controlled over CAPWAP (RFC 5415). It establishes a layer-2 tunneling protocol to encrypt transmission of user data from connected stations. You can configure the following settings:

| Parameter | WLAN Management |
|-----------------------------|---|
| Primary Access Controller | Specifies the primary access controller |
| Secondary Access Controller | Specifies the secondary access controller |

WLAN Configuration

Running in `client` mode, it is possible to connect to one or more remote access-points. The system will switch to the next network in the list in case one goes down and return to the highest-prioritized network as soon as it comes back. You can perform a WLAN network scan and pick the settings from the discovered information directly. The authentication credentials have to be obtained by the operator of the remote access point.

| Parameter | WLAN Client Configuration |
|--------------------------|---|
| SSID | The network name (called SSID) |
| Security mode | The desired security mode |
| WPA/WPA2 mixed mode | WPA2 should be preferred over WPA1, running WPA/WPA2 mixed-mode offers both. |
| WPA cipher | The WPA cipher to be used, the default is to run both (TKIP and CCMP) |
| Identity | The identity used for WPA-RADIUS and WPA-EAP-TLS |
| Passphrase | The passphrase used for authentication with WPA-PSK, otherwise the key passphrase for WPA-EAP-TLS |
| Force PMF | Enables Protected Management Frames |
| Required signal strength | Required signal strength to establish the connection |

The `client` is performing background scans for the purpose of roaming within an ESS. The background scans are based on the current signal strength.

| Parameter | WLAN Client Background Scan Parameters |
|-----------|--|
| Threshold | The signal strength threshold in dBm when the long or short time interval should occur |

| Parameter | WLAN Client Background Scan Parameters |
|----------------|--|
| Long interval | The time in seconds when a background scan should be performed if the threshold is above the given threshold value |
| Short interval | The time in seconds when a background scan should be performed if the threshold is below the given threshold value |

Running in access-point mode you can create up to 4 SSIDs with each running their own network configuration. The networks can be individually bridged to a LAN interface or operate as dedicated interface in routing-mode.

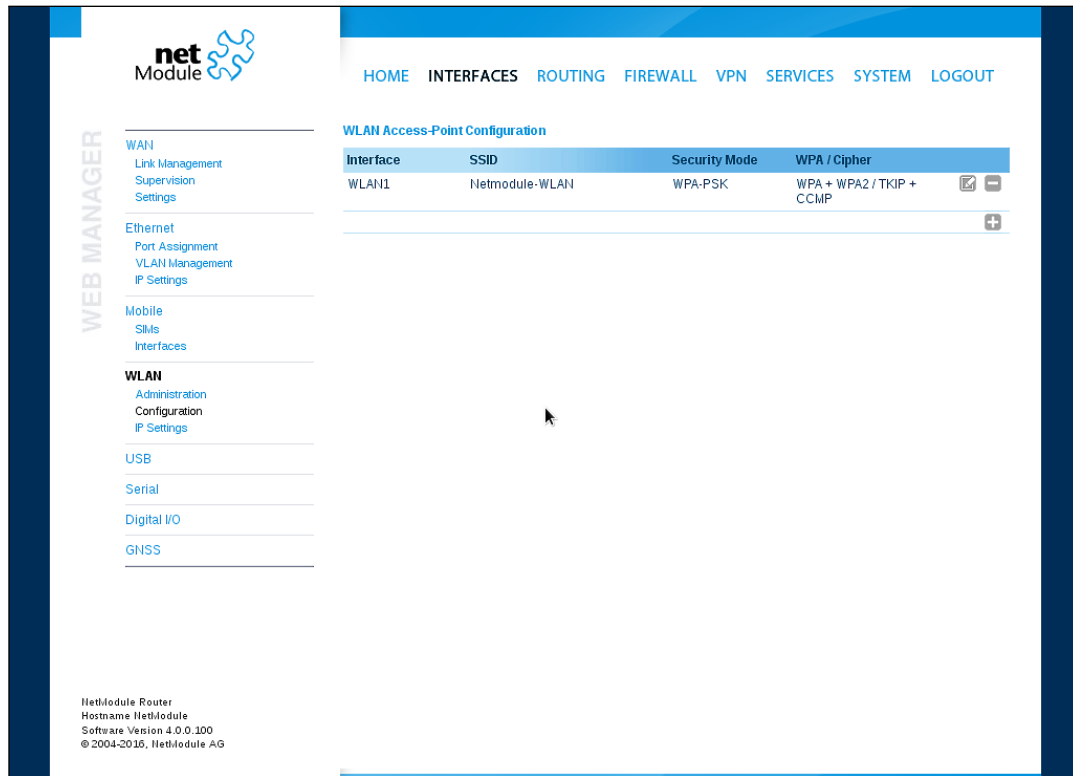

Figure 5.13.: WLAN Configuration

This section can be used to configure security-related settings.

| Parameter | WLAN Access-Point Configuration |
|---------------------|---|
| SSID | The network name (called SSID) |
| Security mode | The desired security mode |
| WPA/WPA2 mixed mode | WPA2 should be preferred over WPA1, running WPA/WPA2 mixed-mode offers both. |
| WPA cipher | The WPA cipher to be used, the default is to run both (TKIP and CCMP) |
| Identity | The identity used for WPA-RADIUS and WPA-EAP-TLS |
| Passphrase | The passphrase used for authentication with WPA-PSK, otherwise the key passphrase for WPA-EAP-TLS |
| Force PMF | Enables Protected Management Frames |
| Hide SSID | Hides the SSID |
| Isolate clients | Disables client-to-client communication |
| Accounting | Sets accounting profile |

The following security modes can be configured:

| Parameter | WLAN Security Modes |
|------------|--|
| Off | SSID is disabled |
| None | No authentication, provides an open network |
| WEP | WEP (is nowadays discouraged) |
| WPA-PSK | WPA-PSK (TKIP, CCMP) aka WPA-Personal/Enterprise, provides password-based authentication |
| WPA-RADIUS | EAP-PEAP/MSCHAPv2, can be used to authenticate against a remote RADIUS server which can be configured in chapter 5.8.2 |
| WPA-TLS | EAP-TLS, performs authentication using certificates which can be configured in chapter 5.8.8 |

WLAN IP Settings

This section lets you configure the TCP/IP settings of your WLAN network. A client interface can be run over DHCP or with a statically configured address and default gateway.

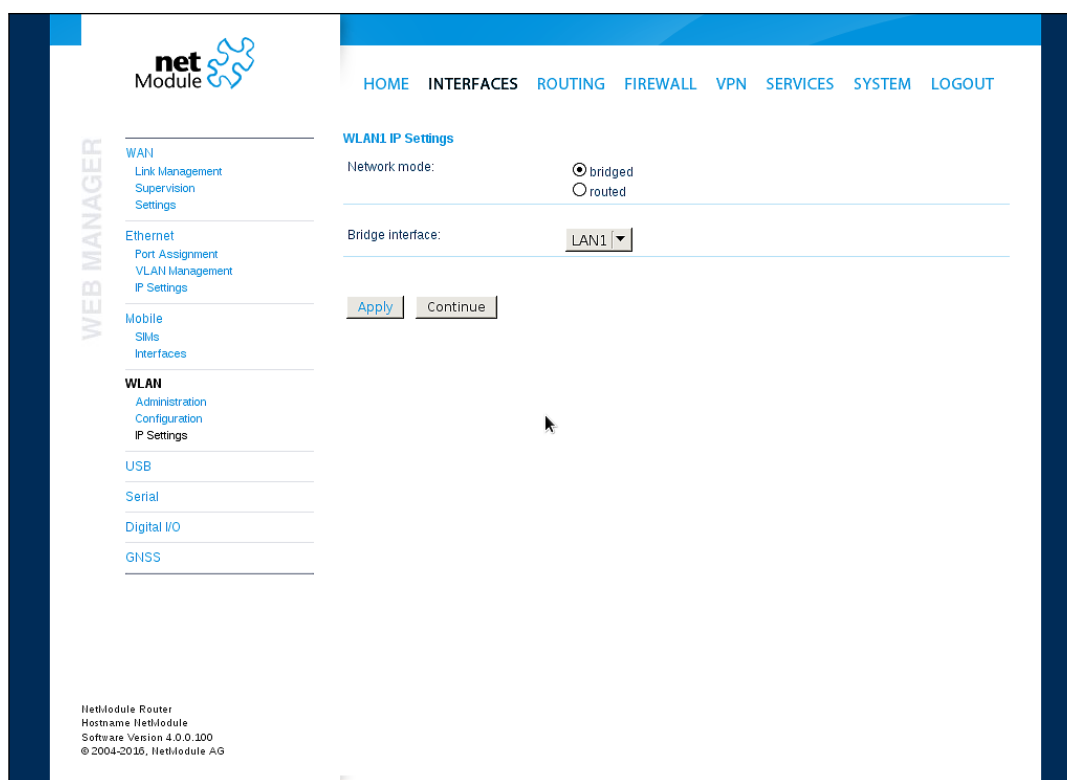

Figure 5.14.: WLAN IP Configuration

The access point networks can be bridged to any LAN interface for letting WLAN clients and Ethernet hosts operate in the same subnet. However, for multiple SSIDs we strongly recommend to set up separated interfaces in routing-mode in order to avoid unwanted access and traffic between the interfaces. The corresponding DHCP server for each network can be configured afterwards as described in chapter 5.7.2.

| Parameter | WLAN IP Settings |
|----------------------|---|
| Network mode | Choose whether the interface shall be operated bridged or in routing-mode |
| Bridge interface | If bridged, the LAN interface to which the WLAN network should be bridged |
| IP address / netmask | In routing-mode, the IP address and netmask for this WLAN network |

5.3.5. Software Bridges

Software bridges can be used to bridge layer-2 devices like OpenVPN TAP, GRE or WLAN interfaces without the need for a physical LAN interface.

Bridge Settings

This page can be used to enable/disable software bridges.

It can be configured as follows:

| Parameter | Bridge Settings |
|-----------------------|---|
| Administrative status | Enables or disables the bridge interface. If you need an interface to the local system you need to define an IP address for the local device. |
| IP Address | IP address of the local interface (available only if "Enabled with local interface" was selected) |
| Netmask | Netmask of the local interface (available only if "Enabled with local interface" was selected) |
| MTU | Optional MTU size for the local interface (available only if "Enabled with local interface" was selected) |

5.3.6. USB

NetModule routers ship with a standard USB host port which can be used to connect a storage, network or serial USB device. Please contact our support in order to get a list of supported devices.

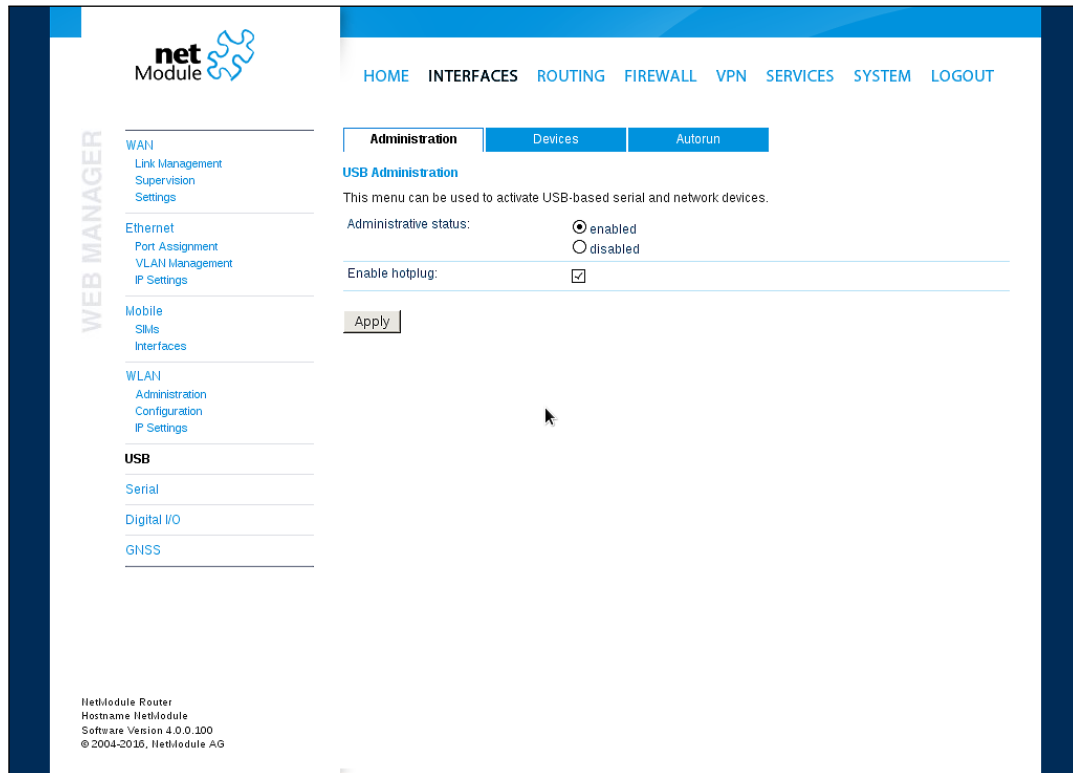

Figure 5.15.: USB Administration

USB Administration

| Parameter | USB Administration |
|-----------------------|---|
| Administrative status | Specifies whether devices shall be recognized |
| Enable hotplug | Specifies whether device shall be recognized if plugged in during runtime or only at bootup |

USB Devices

This page show the currently connected devices and it can be used to enable a specific device based on its Vendor and Product ID. Only enabled devices will be recognized by the system and raise additional ports and interfaces.

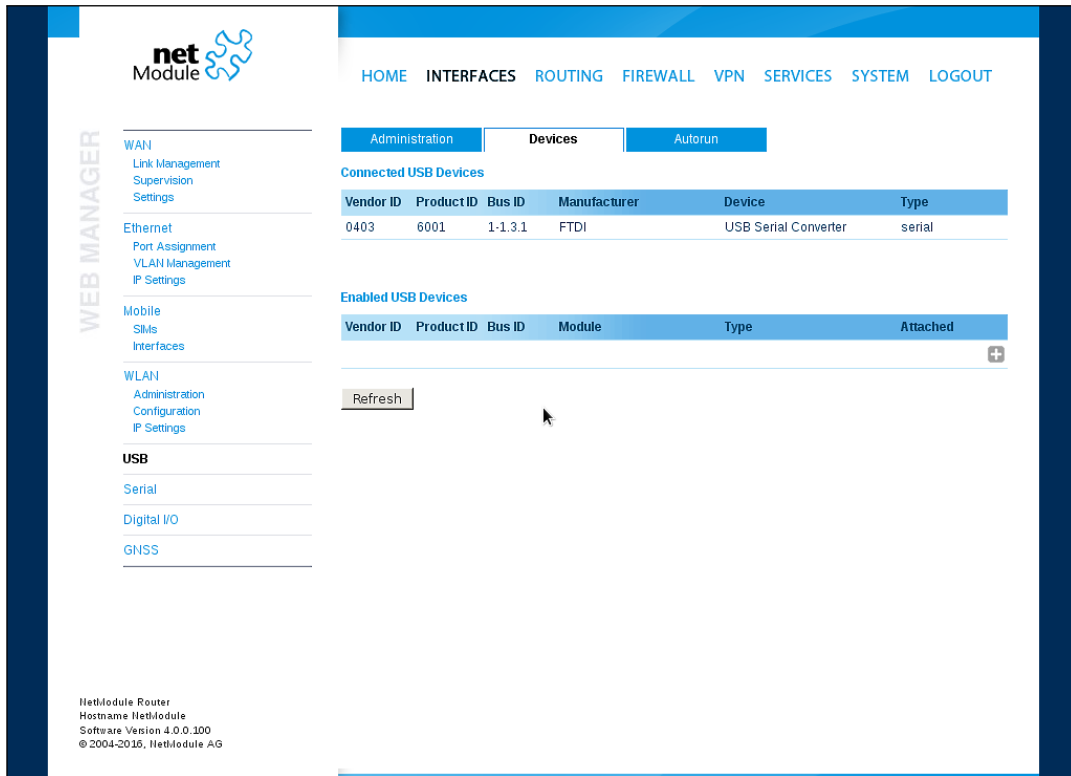

Figure 5.16.: USB Device Management

| Parameter | USB Devices |
|------------|---|
| Vendor ID | The USB Vendor ID of the device |
| Product ID | The USB Product ID of the device |
| Module | The USB module and type of driver to be applied for this device |

Any ID must be specified in hexadecimal notation, wildcards are supported (e.g. AB[0-1][2-3] or AB*) A USB network device will be referenced as LAN10.

USB Autorun

This feature can be used to automatically launch a shell script or perform a software/config update as soon as an USB storage stick has been plugged in. For authentication, a file called `autorun.key` must exist in the root directory of a FAT16/32 formatted stick. It can be downloaded from that page and holds the SHA256 hash key of the admin password. The file can hold multiple hashes which will be processed line-by-line during authentication which can be used for setting up more systems with different admin passwords.

For new devices with an empty password the hash key

```
e3b0c44298fc1c149afbf4c8996fb92427ae41e4649b934ca495991b7852b855
```

can be used.

The hash keys can be generated by running the command `echo -n "<admin-password>" | sha256sum` on a Linux system or an Internet hash key generator (search for "sha-256 hash calculator").

Once authentication has succeeded, the system scans for other files in the root directory which can perform the following actions:

1. For running a script: `autorun.sh`
2. For a configuration update: `cfg-<SERIALNO>.zip` (e.g. `cfg-00112B000815.zip`), or if not available `cfg.zip`
3. For a software update: `sw-update.img`

5.3.7. Serial Port

This page can be used to manage your serial ports. A serial port can be used by:

| Parameter | Serial Port Usage |
|----------------|---|
| none | The serial port is not used |
| login console | The serial port is used to open a console which can be accessed with a serial terminal client from the other side. It will provide helpful bootup and kernel messages and spawns a login shell, so that users can login to the system. |
| device server | The serial port will be exposed over a TCP/IP port and can be used to implement a Serial/IP gateway. |
| modem bridge | Bridges the Serial Interface to the Modem TTY of an intergrated WWAN Modem. |
| modem emulator | Emulates a classical AT command driven modem on the serial interface. See http://wiki.netmodule.com/app-notes/hayes-modem-at-simulator for detailed information. |
| SDK | The serial port will be reserved for SDK scripts. |

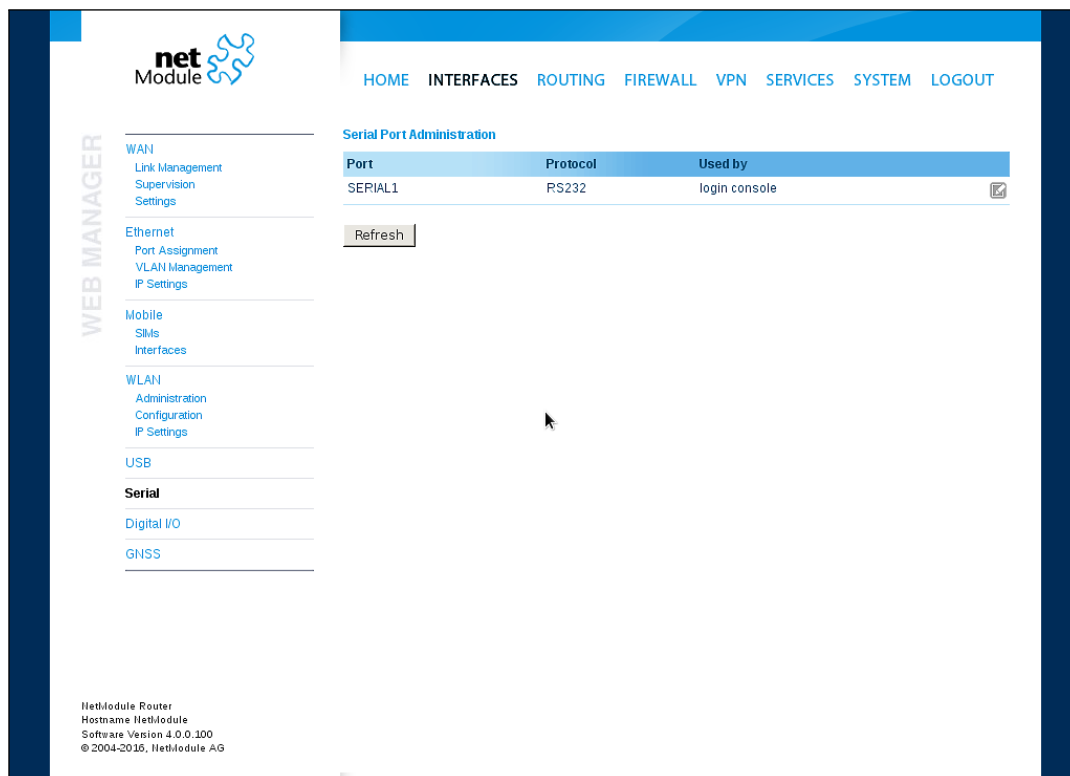

Figure 5.17.: Serial Port Administration

An RS232 serial port is optional on NB3700.

Running a device server, the following settings can be applied:

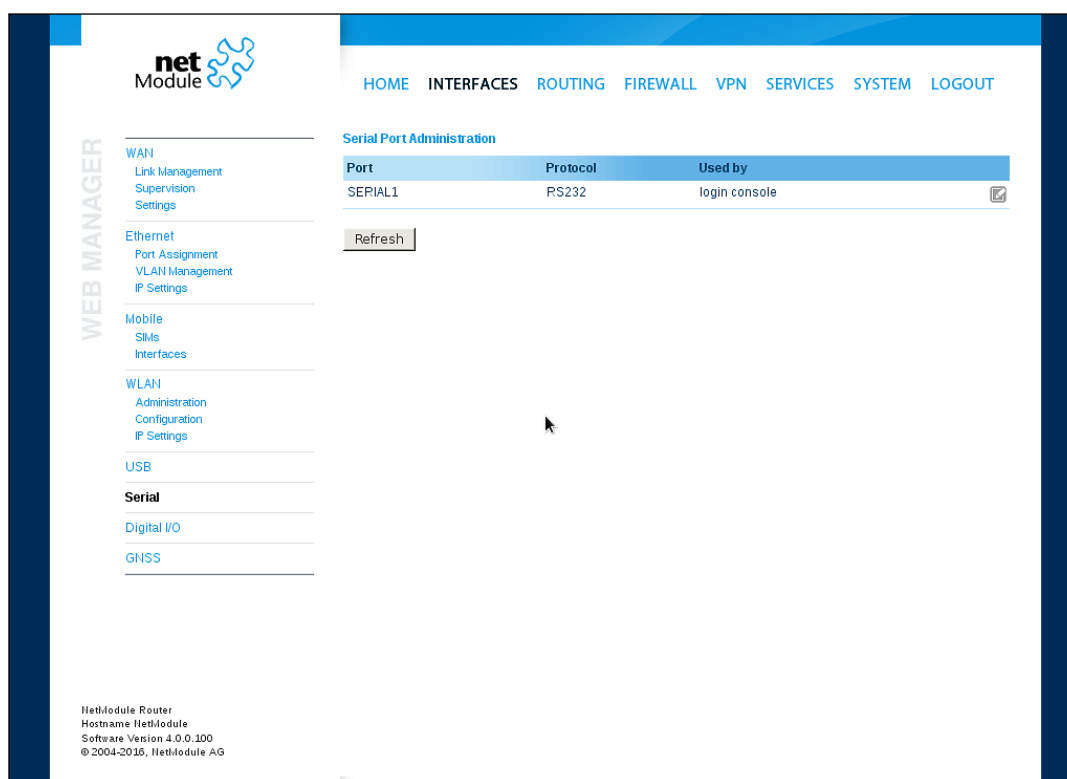

Figure 5.18.: Serial Port Settings

| Parameter | Serial Settings |
|-----------------------|---|
| Physical protocol | Selects the desired physical protocol on the serial port |
| Baud rate | Specifies the baud rate run on the serial port |
| Data bits | Specifies the number of data bits contained in each frame |
| Parity | Specifies the parity used for every frame that is transmitted or received |
| Stop bits | Specifies the number of stop bits used to indicate the end of a frame |
| Software flow control | Defines the software flow control for the serial port, XOFF will send a stop, XON a start character to the other end to control the rate of any incoming data |
| Hardware flow control | You may enable RTS/CTS hardware flow control, so that the RTS and CTS lines are used to control the flow of data |

| Parameter | Serial Settings |
|--------------------|---|
| Protocol on TCP/IP | You may choose the IP protocols <code>Telnet</code> or <code>TCP raw</code> for the device server |
| Port | The TCP port for the device server |
| Timeout | The timeout until a client is declared as disconnected |

| Parameter | Server Settings |
|----------------------|--|
| Protocol on IP port | Selects the desired IP protocol (TCP or Telnet) |
| Port | Specifies the TCP port on which the server will be available |
| Timeout | The time in seconds before the port will be disconnected if there is no activity on it. A zero value disables this function. |
| Allow remote control | Allow remote control (ala RFC 2217) of the serial port |
| Show banner | Show a banner when clients connect |
| Stop bits | Specifies the number of stop bits used to indicate the end of a frame |
| Allow clients from | Specifies which clients are allowed to connect to the server |

Please note that the device server does not provide authentication or encryption and clients will be able connect from everywhere. Please consider to restrict access to a limited network/host or block packets by using the firewall.

When running the serial port as AT modem emulator the following settings can be applied:

| Parameter | Serial Port Settings |
|-----------------------|--|
| Physical protocol | Selects the desired physical protocol on the serial port |
| Baud rate | Specifies the baud rate run on the serial port |
| Hardware flow control | You may enable RTS/CTS hardware flow control, so that the RTS and CTS lines are used to control the flow of data |

| Parameter | Incoming connections via Telnet |
|-----------|------------------------------------|
| Port | The TCP port for the device server |

| Parameter | Phonebook Entries |
|------------|-------------------------------------|
| Number | Phone number that will get an alias |
| IP address | IP address the number will become |
| Port | Port value for the IP address |

5.3.8. Digital I/O

The Digital I/O page displays the current status of the I/O ports and can be used to turn output ports on or off.

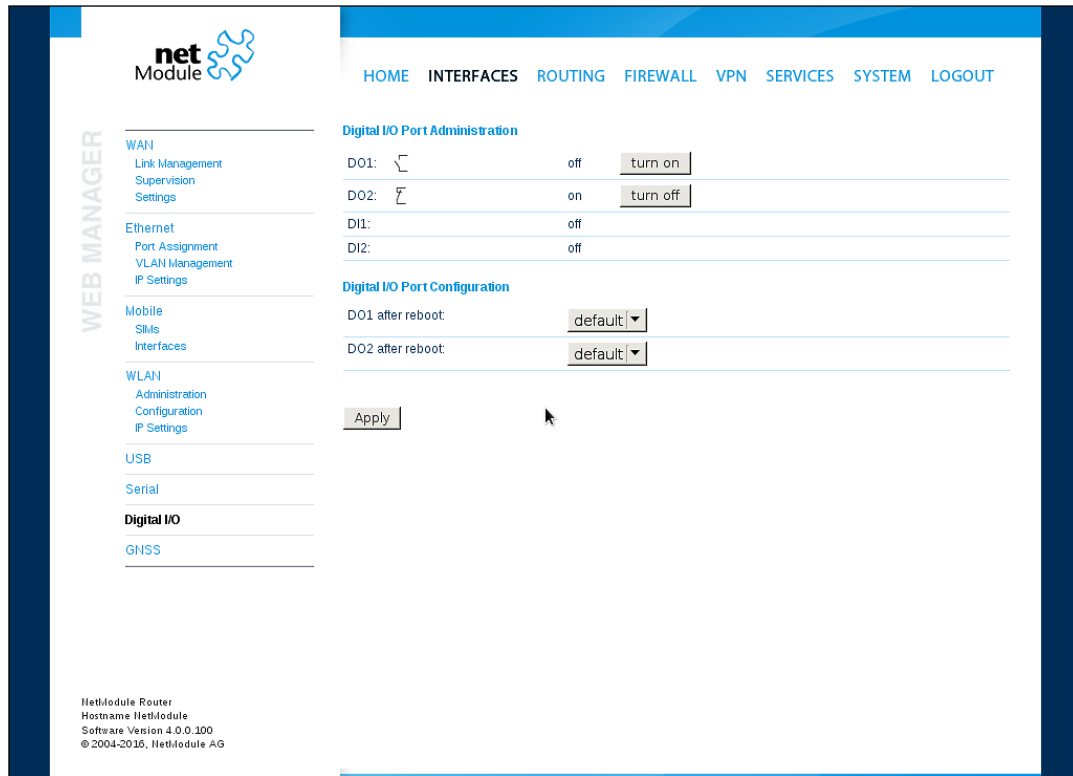

Figure 5.19.: Digital I/O Ports

You can apply the following settings:

| Parameter | Digital I/O Settings |
|------------------|---|
| DO1 after reboot | Initial status of DO1 after system has booted |
| DO2 after reboot | Initial status of DO2 after system has booted |

Besides on and off you may keep the default status as the hardware has initialized it after power-up.

The digital inputs and outputs can also be monitored and controlled by SDK scripts.

5.3.9. GNSS

Administration

The GNSS page lets you enable or disable the GNSS modules present in the system and can be used to configure the daemon that can be used to share access to receivers without contention or loss of data and to respond to queries with a format that is substantially easier to parse than the NMEA 0183 emitted directly by the GNSS device.

We are currently running the Berlios GPS daemon (version 3.15), supporting the new JSON format. Please navigate to <http://www.catb.org/gpsd/> for getting more information about how to connect any clients to the daemon remotely. The position values can also be queried by the CLI and used in SDK scripts.

| Parameter | GNSS Module Configuration |
|-----------------------|--|
| Administrative status | Enable or disable the GNSS module |
| Operation mode | The mode of operation, either standalone or assisted (for A-GPS) |
| Antenna type | The type of the connected GPS antenna, either passive or actively 3 volt powered |
| Accuracy | The desired accuracy in meters |
| Fix frame interval | The amount of time to wait between fix attempts |

| Parameter | GNSS Server Configuration |
|--------------------|---|
| Server port | The TCP port on which the daemon is listening for incoming connections |
| Allow clients from | Specifies where clients can connect from, can be either <code>everywhere</code> or from a specific network |
| Clients start mode | Specifies how data transferal is accomplished when a client connects. You can specify <code>on request</code> which typically requires an <code>R</code> to be sent. Data will be sent instantly in case of <code>raw</code> mode which will provide NMEA frames or <code>super-raw</code> which includes the original data of the GPS receiver. If the client supports the JSON format (i.e. newer <code>libgps</code> is used) the <code>json</code> mode can be specified. |

Please consider to restrict access to the server port, either by a specifying a dedicated client network or by using a firewall rule.

Position

This pages provides further information about the satellites in view and values derived from them:

| Parameter | GNSS Information |
|-----------------------|--|
| Latitude | The geographic coordinate specifying the north-south position |
| Longitude | The geographic coordinate specifying the east-west position |
| Altitude | The height above sea level of the current location |
| Satellites in view | The number of satellites in view as stated in GPGSV frames |
| Speed | The horizontal and vertical speed in meter per second as stated in GPRMC frames |
| Satellites used | The number of satellites used for calculating the position as stated in GPGLA frames |
| Dilution of precision | The dilution of precision as stated in GPGSA frames |

Furtheron, each satellite also comes with the following details:

| Parameter | GNSS Satellite Information |
|-----------|--|
| PRN | The PRN code of the satellite (also referred as satellite ID) as stated in GPGSA frames |
| Elevation | The elevation (up-down angle between the dish pointing direction) in degrees as stated in GPGSV frames |
| Azimuth | The azimuth (rotation around the vertical axis) in degrees as stated in GPGSV frames |
| SNR | The SNR (Signal to Noise Ratio), often referred as signal strength |

Please note that the values are shown as calculated by the daemon, their accuracy might be suggestive.

Supervision

| Parameter | GNSS Supervision |
|-----------------------|--|
| Administrative status | Enable or disable GNSS supervision |
| Mode | Specifies whether to monitor the NMEA stream or GPS fixes |
| Max. downtime | The period of time without valid NMEA stream or GPS fix after which an emergency action shall be taken |

| Parameter | GNSS Supervision |
|------------------|---|
| Emergency action | The corresponding emergency action. You can either let just restart the server, which will also re-initialize the GPS function on the module, or reset the module in severe cases. Please note that this may have effects on any running WWAN/SMS services. |

5.4. ROUTING

5.4.1. Static Routes

This menu shows all routing entries of the system. They are typically formed by an address/netmask couple (represented in IPv4 dotted decimal notation) which specify the destination of a packet. The packets can be directed to either a gateway or an interface or both. If interface is set to ANY, the system will choose the route interface automatically, depending on the best matching network configured for an interface.

The screenshot shows the NetModule Router web interface. The main content area is titled 'Static Routes' and contains a table of routing entries. The table has columns for Destination, Netmask, Gateway, Interface, Metric, and Flags. Below the table is a 'Route lookup' section.

| Destination | Netmask | Gateway | Interface | Metric | Flags |
|---------------|-----------------|----------|-----------|--------|-------|
| 8.8.4.4 | 255.255.255.255 | 0.0.0.0 | WWAN1 | 0 | AH |
| 0.0.0.0 | 0.0.0.0 | 0.0.0.0 | WWAN1 | 0 | AD |
| 10.8.0.0 | 255.255.255.0 | 10.8.0.2 | TUN1 | 0 | AN |
| 10.8.0.2 | 255.255.255.255 | 0.0.0.0 | TUN1 | 0 | AH |
| 192.168.1.0 | 255.255.255.0 | 0.0.0.0 | LAN1 | 0 | AN |
| 192.168.2.0 | 255.255.255.0 | 0.0.0.0 | LAN2 | 0 | AN |
| 192.168.3.0 | 255.255.255.0 | 0.0.0.0 | LAN3 | 0 | AN |
| 192.168.4.0 | 255.255.255.0 | 0.0.0.0 | LAN4 | 0 | AN |
| 192.168.5.0 | 255.255.255.0 | 0.0.0.0 | LAN5 | 0 | AN |
| 192.168.101.0 | 255.255.255.0 | 0.0.0.0 | LAN5-1 | 0 | AN |

Figure 5.20.: Static Routing

In general, host routes precede network routes and network routes precede default routes. Additionally, a metric can be used to determine the priority of a route, a packet will go in the direction with the lowest metric in case a destination matches multiple routes. Netmasks can be specified in CIDR notation (i.e. /24 expands to 255.255.255.0).

| Parameter | Static Route Configuration |
|-------------|--|
| Destination | The destination address of a packet |
| Netmask | The subnet mask which forms, in combination with the destination, the network to be addressed. A single host can be specified by a netmask of 255.255.255.255, a default route corresponds to 0.0.0.0. |
| Gateway | The next hop which operates as gateway for this network (can be omitted on peer-to-peer links) |
| Interface | The network interface on which a packet will be transmitted in order to reach the gateway or network behind it |
| Metric | The routing metric of the interface (default 0), higher metrics have the effect of making a route less favorable |
| Flags | (A)ctive, (P)ersistent, (H)ost Route, (N)etwork Route, (D)efault Route |

The flags obtain the following meanings:

| Flag | Description |
|------|--|
| A | The route is considered active, it might be inactive if the interface for this route is not yet up. |
| P | The route is persistent, which means it is a configured route, otherwise it corresponds to an interface route. |
| H | The route is a host route, typically the netmask is set to 255.255.255.255. |
| N | The route is a network route, consisting of an address and netmask which forms the subnet to be addressed. |
| D | The route is a default route, address and netmask are set to 0.0.0.0, thus matching any packet. |

Table 5.43.: Static Route Flags

5.4.2. Extended Routing

Extended routes can be used to perform policy-based routing, they generally precede static routes.

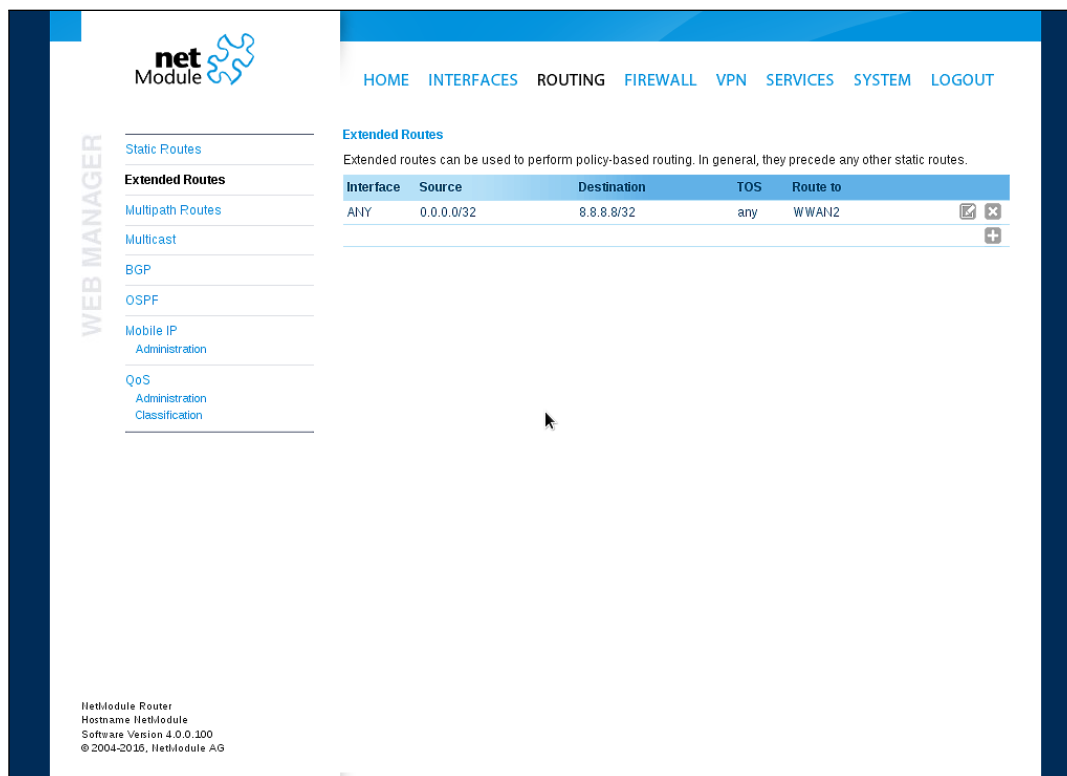

Figure 5.21.: Extended Routing

In contrast to static routes, extended routes can be made up, not only of a destination address/netmask, but also a source address/netmask, incoming interface and the type of service (TOS) of packets.

| Parameter | Extended Route Configuration |
|---------------------|--|
| Source address | The source address of a packet |
| Source netmask | The source address of a packet |
| Destination address | The destination address of a packet |
| Destination netmask | The destination address of a packet |
| Incoming interface | The interface on which the packet enters the system |
| Type of service | The TOS value within the header of the packet |
| Route to | Specifies the target interface or gateway to where the packet should get routed to |
| discard if down | Discard packets if the specified interface is down |

5.4.3. Multipath Routes

Multipath routes will perform weighted IP-session distribution for particular subnets across multiple interfaces.

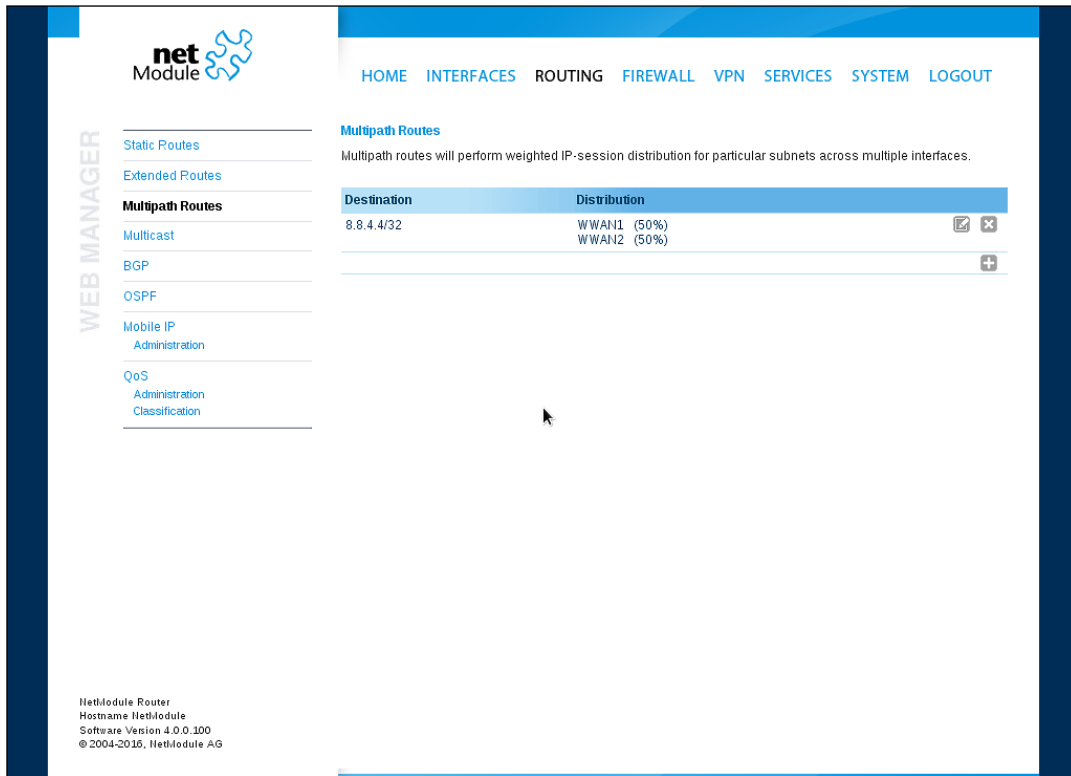

Figure 5.22.: Multipath Routes

At least two interfaces have to be defined to establish multipath routing. Additional interfaces can be added by pressing the plus sign.

| Parameter | Add Multipath Routes |
|------------------------|---|
| Target network/netmask | Defines the target network for which multipath routing shall be applied |
| Interface | Selects the interface for one path |
| Weight | Weight of the interface in relation to the others |
| NextHop | Overrides the default gateway of this interface |

5.4.4. Mobile IP

Mobile IP (MIP) can be used to enable seamless switching between different kinds of WAN links (e.g. WWAN/WLAN). The `mobile node` hereby remains reachable via the same IP address (`home address`) at any time, independently of the WAN link being used. Effectively, any WAN link switch causes very small outages during switchover while keeping all IP connections alive.

Moreover, NetModule routers also support NAT-Traversal for mobile nodes running behind a firewall (performing NAT), which makes mobile nodes even there accessible from a central office via their home address, and thus, bypassing any complicated VPN setups.

The `home agent` accomplishes this by establishing a tunnel (similar to a VPN tunnel) between itself and the `mobile node`. WAN link switching works by telling the `home agent` that the WAN IP address (called the `care-of address` in MIP terms) of the `mobile node` has changed. The `home agent` will then encapsulate packets destined to a `mobile node's` home address into a tunnel packet containing the current `care-of address` of the `mobile node` as its destination address.

To prevent problems with firewalls and private IP addressing, the MIP implementation always employs reverse tunneling, which means that all traffic sent by a `mobile node` is relayed via the tunnel to the `home agent` instead of directly being conveyed to the final destination. This fact also empowers MIP to be used as a lightweight VPN replacement (without payload secrecy).

The MIP implementation supports RFCs 3344, 5177, 3024 and 3519. For applications requiring vast numbers of mobile nodes, interoperability with the Cisco 2900 Series `home agent` implementation has been verified. However, since NetModule routers implement a `mobile node` as well as a `home agent`, a MIP network with up to 10 mobile nodes can be implemented without requiring expensive third party routers.

If MIP is run as a `mobile node`, the following settings can be configured:

| Parameter | Mobile IP Configuration |
|------------------------------|---|
| Primary home agent address | The address of the primary <code>home agent</code> |
| Secondary home agent address | The address of the secondary <code>home agent</code> . The <code>mobile node</code> will try to register with this <code>home agent</code> , if the primary <code>home agent</code> is not reachable. |
| Home address | The permanent home address of the <code>mobile node</code> which can be used to reach the mobile router at any time |

| Parameter | Mobile IP Configuration |
|------------------------|--|
| SPI | The Security Parameter Index (SPI) identifying the security context for the mobile IP tunnel between the <code>mobile node</code> and the <code>home agent</code> . This is used to distinguish mobile nodes from each other. Therefore each mobile node needs to be assigned a unique SPI. This is a 32-bit hexadecimal value. |
| Authentication type | The used authentication algorithm. This can be <code>prefix-suffix-md5</code> (default for MIP) or <code>hmac-md5</code> . |
| Shared secret | The shared secret used for authentication of the <code>mobile node</code> at the <code>home agent</code> . This can be either a 128-bit hexadecimal value or a random length ASCII string. |
| Life time | The lifetime of security associations in seconds |
| UDP encapsulation | Specifies whether UDP encapsulation shall be used or not. To allow NAT traversal, UDP encapsulation must be enabled. |
| Mobile network address | Optionally specifies a subnet which should be routed to the <code>mobile node</code> . This information is forwarded via Network Mobility (NEMO) extensions to the <code>home agent</code> . The <code>home agent</code> can then automatically add IP routes to the subnet via the <code>mobile node</code> . Note that this feature is not supported by all third party <code>home agent</code> implementations. |
| Mobile network mask | The network mask for the optional routed network |

If MIP is run as a `home agent`, you will have to set up a home address and network mask for the `home agent` first. Then you will need to add the configuration for all mobile nodes which is made up of the following settings:

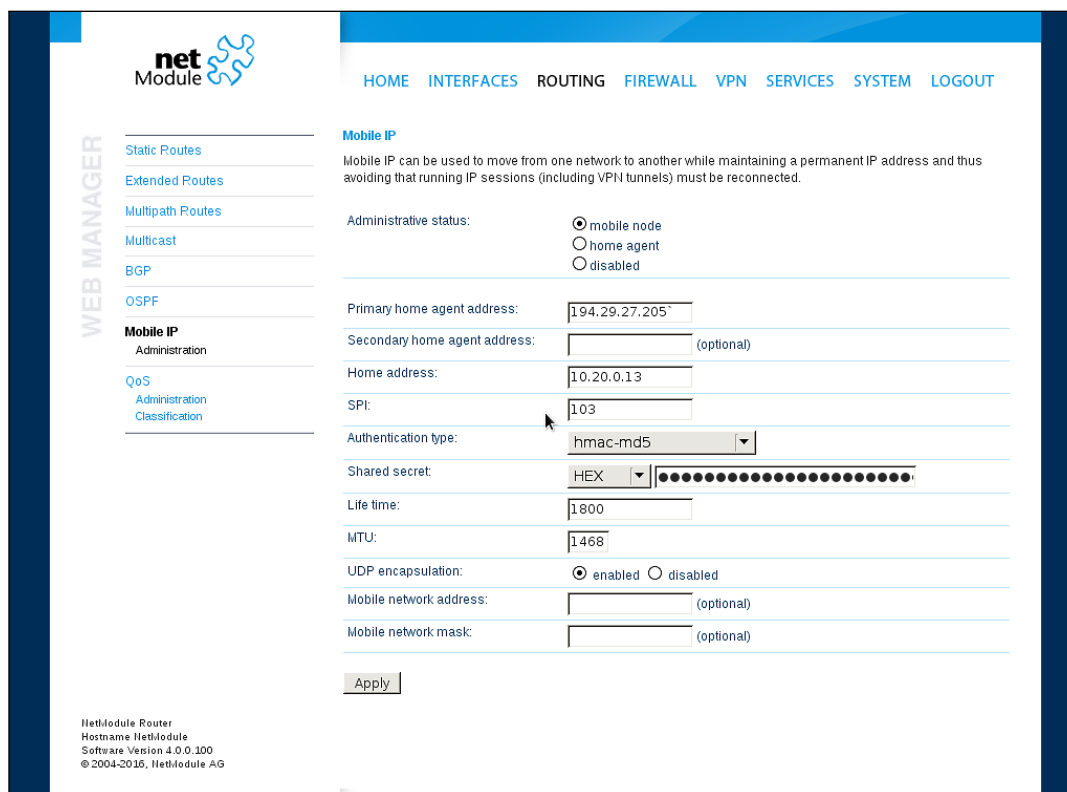

Figure 5.23.: Mobile IP

| Parameter | Mobile IP Node Configuration |
|---------------------|--|
| SPI | The Security Parameter Index (SPI) identifying the security context for the tunnel between the <code>mobile node</code> and the <code>home agent</code> . This is used to distinguish mobile nodes from each other. Therefore each <code>mobile node</code> needs to be assigned a unique SPI. This is a 32-bit hexadecimal value. |
| Authentication type | The used authentication algorithm. This can be prefix-suffix-md5 (default for mobile IP) or hmac-md5. |
| Shared secret | The shared secret used for authentication of the <code>mobile node</code> at the <code>home agent</code> . This can be either a 128-bit hexadecimal value or a random length ASCII string. |

5.4.5. Quality Of Service

NetModule routers are able to prioritize and shape certain kinds of IP traffic. This is currently limited on egress, which means that only outgoing traffic can be stipulated.

The current QoS solution is using Stochastic Fairness Queueing (SFQ) classes in combination with Hierarchy Token Bucket (HTB) qdiscs. Its principle of operation can be summarized as ceiling the max. throughput per link and shaping traffic by reflecting the specified queue priorities. In general, the lowest priority number of a queue gets most out of the available bandwidth.

In case of demands for other class or qdisc algorithms please contact our support team in order to evaluate the best approach for your application.

QoS Administration

The administration page can be used to enable and disable QoS.

QoS Classification

The classification section can be used to define the WAN interfaces on which QoS should be active.

| Parameter | QoS Interface Parameters |
|------------------------|--|
| Interface | The WAN interface on which QoS should be active |
| Bandwidth congestion | The bandwidth congestion method. In case of <code>auto</code> the system will try to apply limits in a best-effort way. However, it is suggested to set fixed bandwidth limits as they also offer a way of tuning the QoS behaviour. |
| Downstream bandwidth | The available bandwidth for incoming traffic |
| Upstream bandwidth | The available bandwidth for outgoing traffic |
| IP to ping (primary) | An IP, which answers ICMP echo requests to determine the bandwidth of the link |
| IP to ping (secondary) | An IP, which answers ICMP echo requests to determine the bandwidth of the link |

When defining limits, you should consider bandwidth limits which are at least possible as most shaping and queues algorithms will not work correctly if the specified limits cannot be achieved. In particular, any WWAN interfaces operating in a mobile environment are suffering variable bandwidths, thus rather lower values should be used.

In case an interface has been activated, the system will automatically create the following queues:

| Parameter | QoS Default Queues |
|-----------|--|
| high | A high priority queue which may hold any latency-critical services (such as VoIP) |
| default | A default queue which will handle all other services |
| low | A low priority queue which may hold less-critical services for which shaping is intended |

Each queue can be configured as follows:

| Parameter | QoS Queue Parameters |
|-----------|--|
| Name | The name of the QoS queue |
| Priority | A numerical priority for the queue, lower values indicate higher priorities |
| Bandwidth | The maximum possible bandwidth for this queue in case the total bandwidth of all queues exceeds the set upstream bandwidth of "QoS Interface Parameters" |
| Set TOS | The TOS/DiffServ value to set on matching packets |

You can now configure and assign any services to each queue. The following parameters apply:

| Parameter | QoS Service Parameters |
|------------------|---|
| Interface | The QoS interface of the queue |
| Queue | The QoS queue to which this service shall be assigned |
| Source | Specifies a network address and netmask used to match the source address of packets |
| Destination | Specifies a network address and netmask used to match the destination (target) address of packets |
| Protocol | Specifies the protocol for packets to be matched |
| Source Port | Specifies the source port for packets to be matched |
| Destination Port | Specifies the destination port for packets to be matched |
| Type of Service | Specifies the TOS/DiffServ for packets to be matched |

5.4.6. Multicast

Multicast routing (MCR) can be configured and managed by a daemon. Only one MCR daemon can be used at a time.

NetModule routers ship with two different MCR daemons to select from depending on your dependencies:

| Parameter | Administrative Status |
|---------------|--|
| IGMP proxy | Forwarding of multicast messages that are dynamically detected on a given interface to another interface |
| static routes | List of MCR rules to forward messages of dedicated source and group from a given interface to another |
| disabled | Disable routing of multicast messages |

IGMP proxy

IGMP proxy which is able to maintain multicast groups on a particular interface and distribute incoming multicast packets towards the downstream interfaces on which hosts have joined the groups.

| Parameter | Multicast Routing Settings |
|-----------------------|--|
| Administrative status | Specifies whether multicast routing is active |
| Incoming interface | The upstream interface on which multicast groups are joined and on which multicast packets come in |
| Distribute to | Specifies the downstream interfaces to which multicast packets will be forwarded |

Static Routes

Routes multicast messages in different directions depending on their origin and group based on a given set of MCR rules:

| Parameter | Static Multicast Route |
|--------------------|---|
| Group | IP address of MCR group |
| Source | Source-IP of the packets |
| Incoming interface | Interface to listen on for messages of given group and source |
| Outgoing interface | Interface to forward the messages to |

5.4.7. OSPF

The OSPF tab allows the NetModule router to be added to a network of OSPF routers.

| Parameter | OSPF General Settings |
|-------------------------------|---|
| OSPF status | Specifies whether the OSPF routing protocol is active |
| Redistribute connected routes | Redistribute routes to networks which are directly connected to the NetModule router |
| Redistribute local routes | Redistribute routes from the NetModule router's own routing table |
| Redistribute BGP routes | Redistribute routes learned via the BGP routing protocol |
| Redistribute default route | Redistribute the routers default route |
| Disable BGP when VRRP slave | Disables the OSPF protocol when the router is set to slave mode by the VRRP redundancy protocol |

The interfaces tab is used to define OSPF specific settings for the IP interfaces of the router. If no settings are defined for a specific interface, default settings will be used.

| Parameter | OSPF Interfaces |
|----------------|---|
| Interface | The name of the interface for which settings shall be defined |
| Authentication | The authentication protocol to be used on the interface to authenticate OSPF packets |
| Key | The key to be used for authentication |
| Key ID | The ID of the key to be used for authentication (1-255) |
| Cost | The cost for sending packets via this interface. If not specified or set to 0 OSPF defaults are used. |
| Passive | Do not send out OSPF packets on this interface |

The networks tab defines the IP networks to be handled in OSPF as well as to which routing area they belong.

| Parameter | OSPF Networks |
|---------------|--|
| Prefix | Prefix of the network |
| Prefix length | Length of the prefix |
| Area | Routing area to which this interface belongs (0-65535, 0 means backbone) |

5.4.8. BGP

The BGP tab allows to set up peerings of the NetModule router with other Border Gateway Protocol enabled routers.

| Parameter | BGP General Settings |
|-------------------------------|--|
| BGP status | Specifies whether the BGP routing protocol is active |
| AS number | The number of the autonomous system to which the NetModule router belongs (1-4294967295) |
| Redistribute connected routes | Redistribute routes to networks which are directly connected to the NetModule router |
| Redistribute local routes | Redistribute routes from the NetModule router's own routing table |
| Redistribute OSPF routes | Redistribute routes learned via the OSPF routing protocol |
| Disable BGP when VRRP slave | Disables the BGP protocol when the router is set to slave mode by the VRRP redundancy protocol |

The neighbors tab is used to configure all the BGP routers to peer with.

| Parameter | BGP Neighbors |
|------------|---|
| IP address | IP address of the peer router |
| As number | Autonomous system number of the peer router (1-4294967295) |
| Password | Password for authentication with the peer router. If left blank authentication is disabled. |
| Multihop | Allow multiple hops between this router and the peer router instead of requiring the peer to be directly connected. |

The Networks tab allows to add IP network prefixes that shall be distributed via BGP in addition to the networks that are redistributed from other sources as defined on the general tab.

| Parameter | BGP Networks |
|---------------|---|
| Prefix | Prefix of the network to be distributed |
| Prefix length | Length of the prefix to be distributed |

5.5. FIREWALL

5.5.1. Administration

NetModule routers use Linux's netfilter/iptables firewall framework (see <http://www.netfilter.org> for more information) which supports stateful inspection, that is, granting the same permissions for inherited connections within an IP session (e.g. FTP which builds up a control and data connection).

The administration page can be used to enable and disable firewalling. When turning it on, a shortcut can be used to generate a predefined set of rules which allow administration (over HTTP, HTTPS, SSH or TELNET) by default but block any other packets coming from the WAN interface.

5.5.2. Address/Port Groups

This menu can be used to form address or port groups which can be later used for firewall rules in order to reduce the number of rules. If address or port groups have been referenced, packets will match if one of the configured entities apply to the packet.

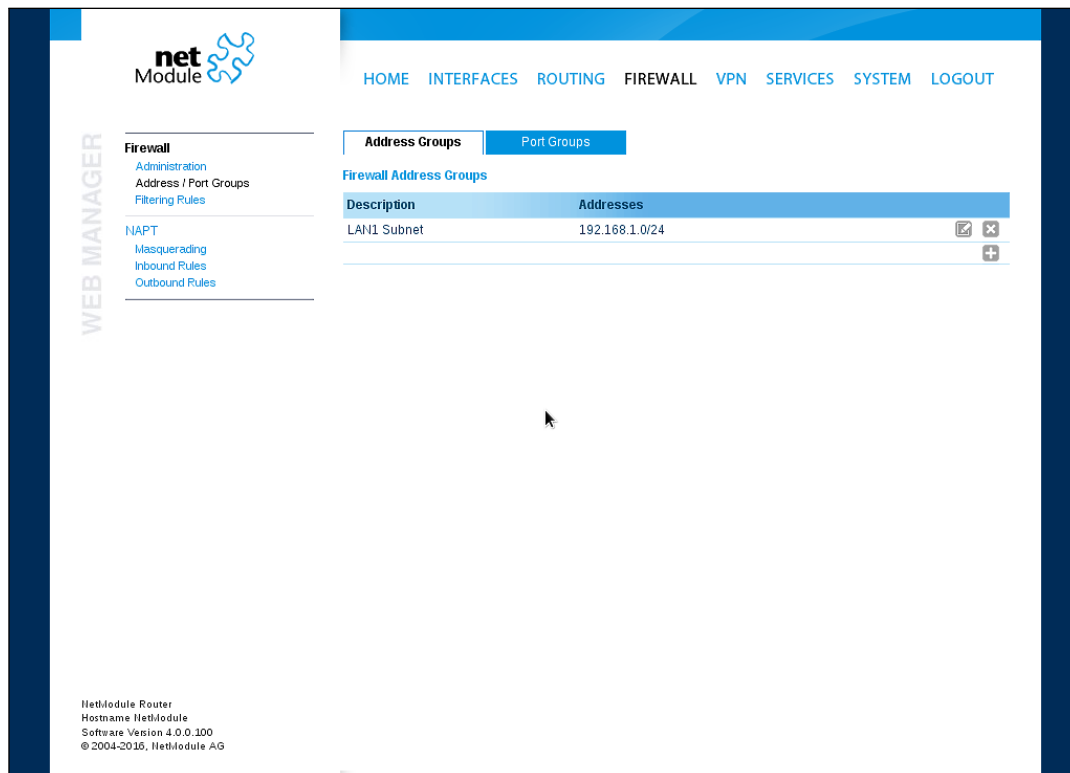

The screenshot shows the NetModule Web Manager interface. The top navigation bar includes links for HOME, INTERFACES, ROUTING, FIREWALL, VPN, SERVICES, SYSTEM, and LOGOUT. The left sidebar is labeled 'WEB MANAGER' and contains a 'Firewall' section with links for Administration, Address / Port Groups, and Filtering Rules, as well as a 'NAPT' section with links for Masquerading, Inbound Rules, and Outbound Rules. The main content area is titled 'Firewall Address Groups' and has two tabs: 'Address Groups' and 'Port Groups'. Below the tabs is a table with the following data:

| Description | Addresses | |
|-------------|----------------|---|
| LAN1 Subnet | 192.168.1.0/24 | <input type="checkbox"/> <input type="checkbox"/> |

At the bottom left of the page, the following information is displayed: NetModule Router, Hostname: NetModule, Software Version 4.0.0.100, ©2004-2016, NetModule AG.

Figure 5.24.: Firewall Groups

5.5.3. Rules

In general, the firewall is set up of a range of rules which control each packet's permission to pass the router. Please note that the rules are processed by order, that means traversing the list from top to bottom until a matching rule is found. Packets which are not matching any of the rules configured will be ALLOWED.

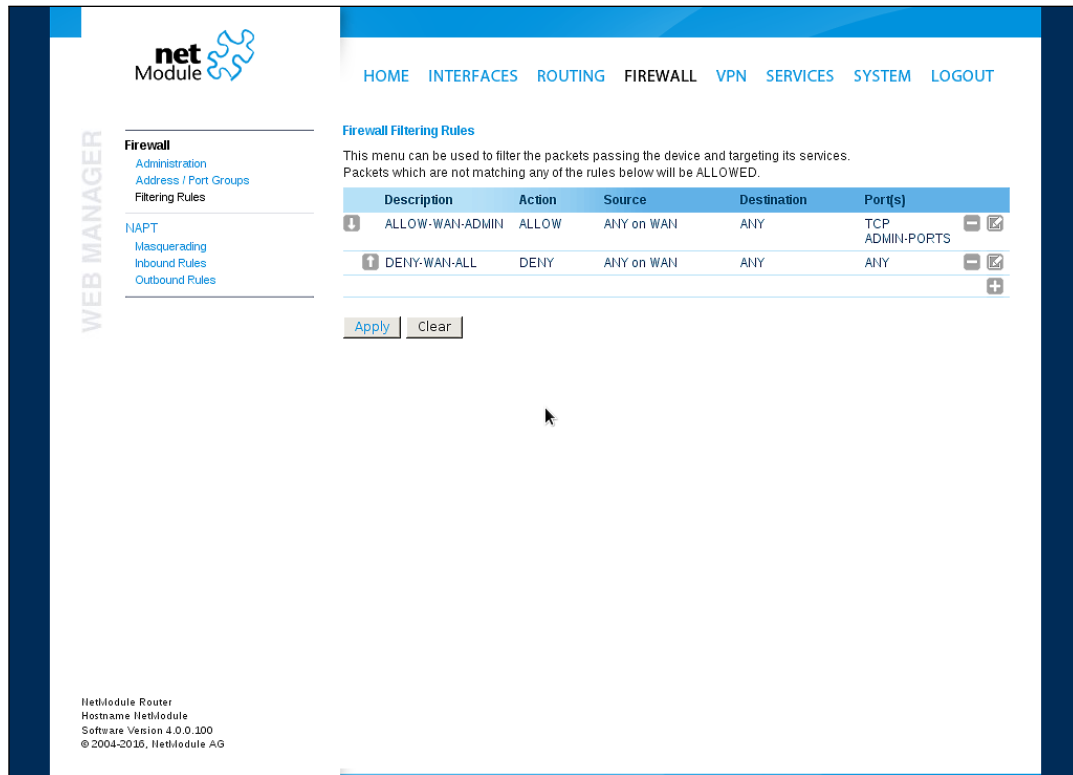

Figure 5.25.: Firewall Rules

| Parameter | Firewall Rule Configuration |
|--------------------|--|
| Description | A meaningful description about the purpose of this rule |
| Action | Specifies whether the packets of this rule should be allowed or denied |
| log matches | Throw a syslog message if rule matches |
| Source | The source address of matching packets, can be any or specified by address/network. Selecting on source MAC addresses is possible as well. |
| Destination | The destination address of matching packets, can be any, local (addressed to the system itself) or specified by address/network |
| Incoming interface | The interface on which matching packets are received |

| Parameter | Firewall Rule Configuration |
|---------------------|---|
| Protocol | The used IP protocol of matching packets (UDP, TCP or ICMP) |
| Destination port(s) | The destination port of matching packets, which can be specified by a single port or a range of ports (only UDP/TCP). |

The statistics page can be used to figure out if rules have matched any packets and provides a convenient way to debug your firewall setup.

5.5.4. NAT

This page can be used to configure Network Address and Port Translation (NAPT) for packets traversing the system. NAT hereby modifies IP addresses or/and TCP/UDP ports in matching IP packets. By tracking those connections, it will also automatically adjust the returning packets of an IP session.

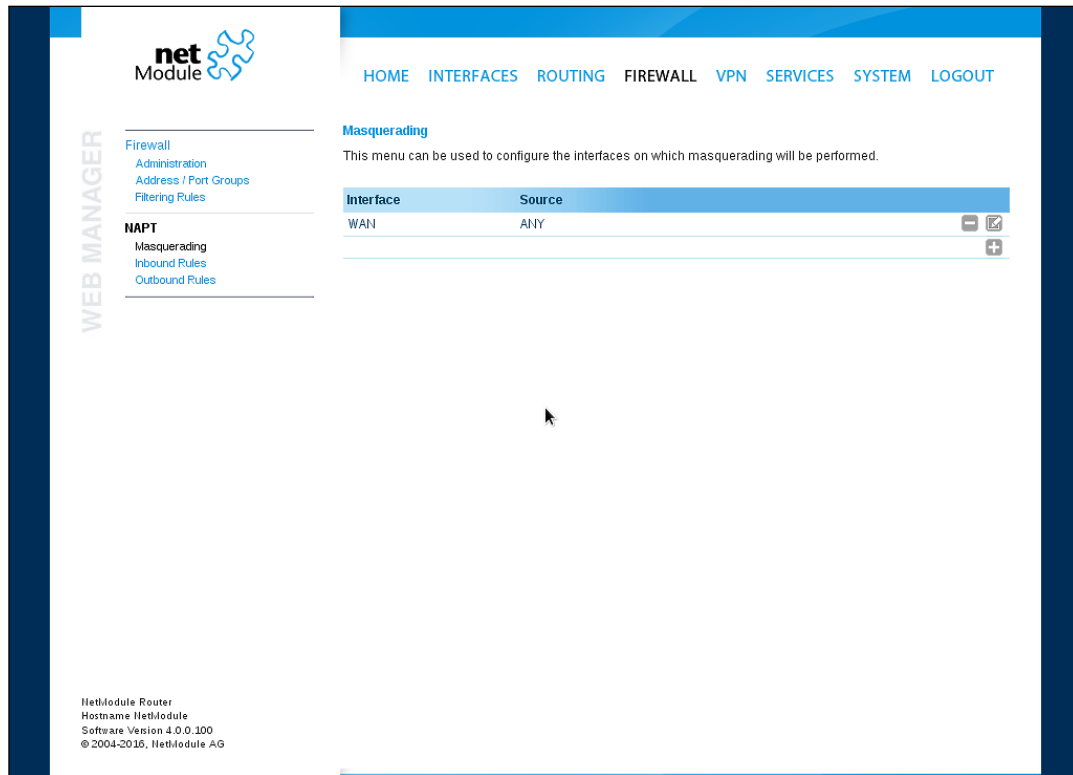

Figure 5.26.: Masquerading

The administration page lets you specify the interfaces on which masquerading will be performed. NAT will hereby use the address of the selected interface and choose a random source port for outgoing connections and thus enables communication between hosts from a private local area network towards hosts on the public network.

| Parameter | Masquerading Rules |
|----------------|---|
| Interface | The outgoing interface on which connections will be masqueraded |
| Source address | The source address or network from which matching packets are masqueraded |
| Source netmask | The source netmask of the network from which matching packets are masqueraded |

NAPT Inbound Rules

Inbound rules can be used to modify the target section of IP packets and, for instance, forward a service or port to an internal host. By doing so, you can expose that service and make it available from the Internet. You may also establish 1:1 NAT mapping for a single host using additional outbound rules.

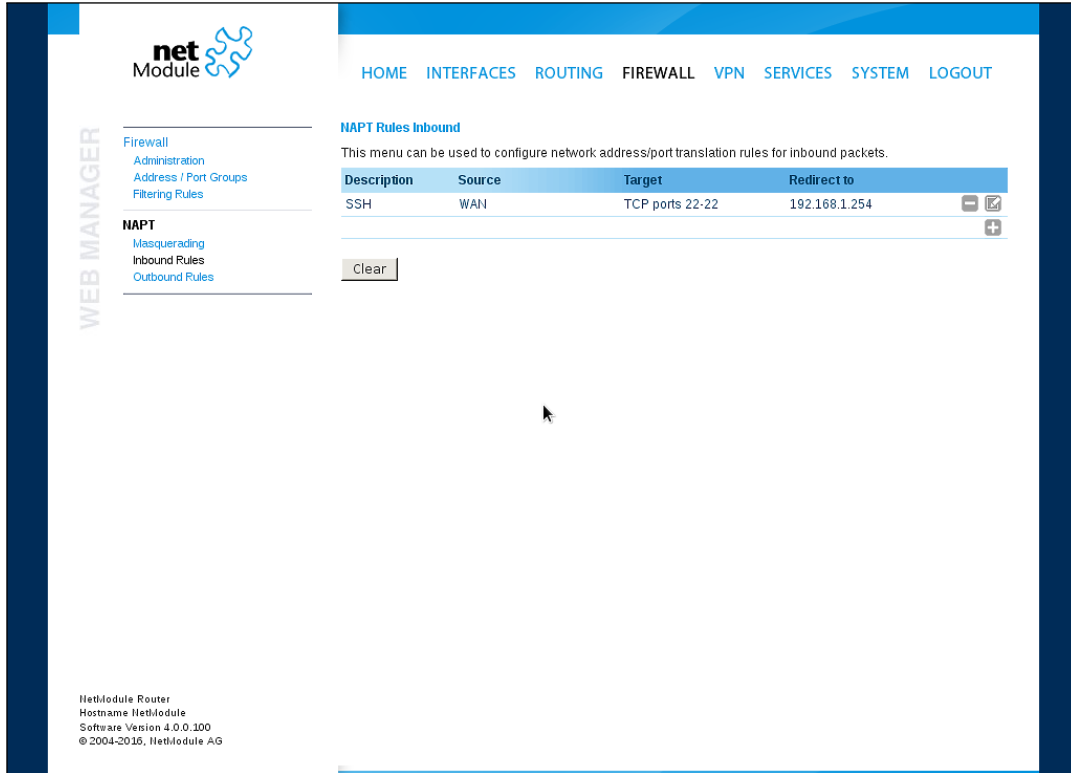

Figure 5.27.: Inbound NAPT

Please note that the specified rules are processed by order, that means, traversing the list from top to bottom until a matching rule is found. If there is no matching rule found, the packet will pass as is.

| Parameter | Inbound NAPT Rules |
|--------------------|--|
| Description | A meaningful description of this rule |
| Map | Context for this rule: Host, Network or Port-Range - see table below |
| Incoming interface | The interface from which matching packets are received |
| Source | The source address or network from which matching packets are received |
| Target address | The destination address of matching packets (optional) |
| Protocol | The used protocol of matching packets |

| Parameter | Inbound NAT Rules |
|---------------|---|
| Ports | The used UDP/TCP port of matching packets |
| Redirect to | The address to which matching packets shall be redirected |
| Redirect port | The port to which matching packets will be redirected |

Select mapping context according to your needs:

| Parameter | Mapping contexts |
|------------|--|
| host | Rewrite destination address and port for one given host (i.e. 10.0.0.1:8080 → 192.168.1.100:80) |
| network | Rewrite destination address for a full network (i.e. 10.0.0.0/24 → 192.168.1.0/24) |
| port range | Rewrite destination address and port based on the incoming port (i.e. 10.0.0.1:22000-22255 → 192.168.1.0/24:22). There is no corresponding rule for port range translation in outbound rules. Use network based mapping there. |

NAPT Outbound Rules

Outbound rules will modify the source section of IP packets and can be used to establish 1:1 NAT mappings but also to redirect packets to a specific service.

| Parameter | Outbound NAT Rules |
|------------------------|--|
| Description | A meaningful description of this rule |
| Outgoing interface | The outgoing interface on which matching packets are leaving the router |
| Target | The target address or network to which matching packets are destined |
| Source address | The source address of matching packets (optional) |
| Protocol | The used protocol of matching packets |
| Ports | The used UDP/TCP port of matching packets |
| Rewrite source address | The address to which the source address of matching packets shall be rewritten |
| Rewrite source port | The port to which the source port of matching packets shall be rewritten |

5.6. VPN

5.6.1. OpenVPN

OpenVPN Administration

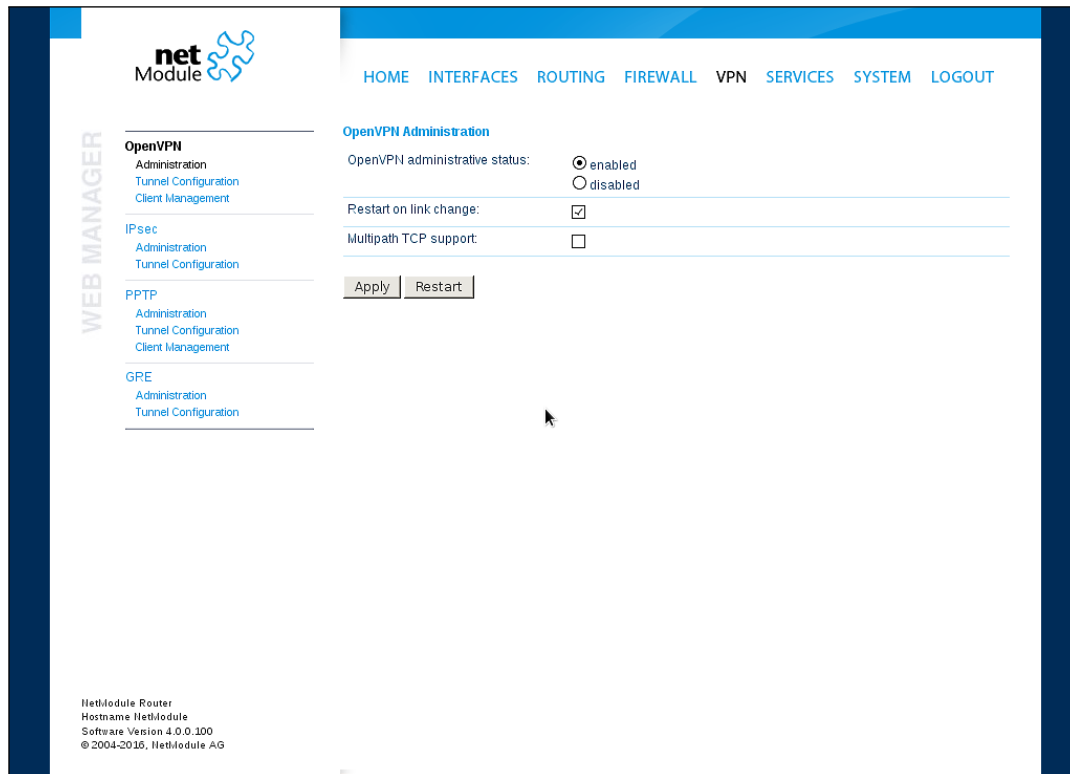

Figure 5.28.: OpenVPN Administration

Tunnel Configuration

NetModule routers support one single server tunnel and up to four client tunnels. You can specify tunnel parameters either in standard configuration or upload an expert mode file which has been created in advance. Refer to chapter 5.6.1 to learn more about how to manage clients and generate the files.

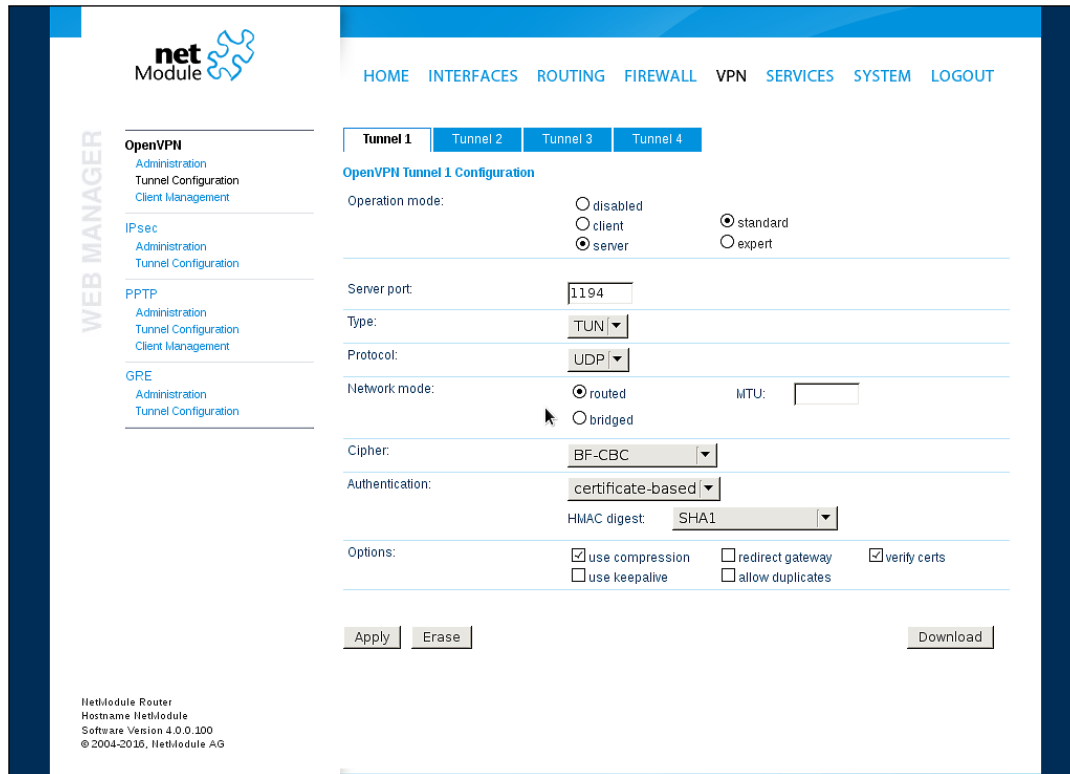

Figure 5.29.: OpenVPN Configuration

| Parameter | OpenVPN Configuration |
|----------------|---|
| Operation mode | Specifies whether client or server mode should be used for this tunnel, it further specifies if tunnel shall be configured in a standard way or if an expert mode file shall be used. |
| Multipath TCP | Enables OpenVPN multipath TCP support |

If the tunnel is operated in client mode, the following settings can be applied:

| Parameter | OpenVPN Client Configuration |
|----------------|--|
| Peer selection | Specifies how the remote peer shall be selected, besides a single server you may configure multiple servers which can, in case of failures, either be selected sequently (i.e. failover) or randomly (i.e. load balancing) |
| Server | The address or hostname of the remote server |
| Port | The port of the remote server (1194 by default) |

The following settings can be used to configure a tunnel:

| Parameter | OpenVPN Configuration |
|----------------|--|
| Interface type | The device type for this tunnel which can be either TUN (typically used for routed connections) or TAP (required for bridged networks) |
| Protocol | The tunnel protocol to be used for the transport connection |
| Network mode | Defines how the packets should be forwarded, which can be either routed or bridged from/to a particular LAN interface. If required, you can also specify the maximum transfer unit for the tunnel interface. |
| MTU | The Maximum Transmission Unit of the tunnel interface |
| Encryption | The required cipher mechanism used for encryption |
| Digest | The digest algorithm used for authenticating |

Authentication can be done in the following ways:

| Parameter | OpenVPN Authentication |
|-------------------|--|
| certificate-based | Certificates and keys for authenticating the tunnel. Please take care that the proper keys/certificates have been either uploaded or generated (see 5.8.8). |
| credential-based | Username and password are used for authentication. |
| both | Verifying the tunnel uses certificates and credentials. |
| none | Tunnel is not authenticated (discouraged) |

The following further options can be applied:

| Parameter | OpenVPN Options |
|------------------|---|
| use compression | Enable or disable LZO packet compression |
| use keepalive | Can be used to send a periodic keepalive packet in order to keep the tunnel up despite of inactivity |
| redirect gateway | By redirecting the gateway, all packets will be directed to the VPN tunnel. Please ensure that essential services (such as DNS or NTP servers) can be reached at the network behind the tunnel. In doubt, create an extra static route pointing to the correct interface. |
| allow duplicates | Allow multiple clients with the same common name to concurrently connect. |
| verify certs | Check peer certificate against local CRL. |
| negotiate DNS | If enabled, the system will use the nameservers which have been negotiated over the tunnel. |

OpenVPN Expert Configuration (Client)

The expert configuration mode offers a straightforward way to configure a tunnel by simply uploading a zip package containing the required configuration and optionally key/certificate files. A client tunnel usually consists of the following files:

| Parameter | Client Expert Files |
|-------------|--|
| client.conf | OpenVPN configuration file (see http://www.openvpn.net for available options) |
| ca.crt | Root certificate authority file |
| client.crt | Certificate file |
| client.key | Private key file |
| client.p12 | PKCS#12 file |
| ta.key | TLS authentication key file |

Please note that you may specify arbitrary file names, however, the configuration file suffix must be `.conf` and all files referred in the configuration file must correspond to relative path names.

OpenVPN Expert Configuration (Server)

A server tunnel typically requires the following files:

| Parameter | Server Expert Files |
|-------------|--|
| server.conf | OpenVPN configuration file |
| ca.crt | Root certificate authority file |
| server.crt | Certificate file |
| server.key | Private key file |
| dh1024.pem | Diffie-Hellman parameters file |
| ccd | A directory containing client-specific configuration files |

Keep in mind that a certificate becomes valid once its validity time has been reached, thus an accurate system has to be set prior to creating certificates and establishing a tunnel connection. Please ensure that all NTP servers are reachable. Using host names also requires a working DNS server.

Client Management

Once you have successfully set up an OpenVPN server tunnel, you can manage and enable clients connecting to your service. Currently connected clients can be seen on this page, including the connect time and IP address. You may kick connected clients by disabling them.

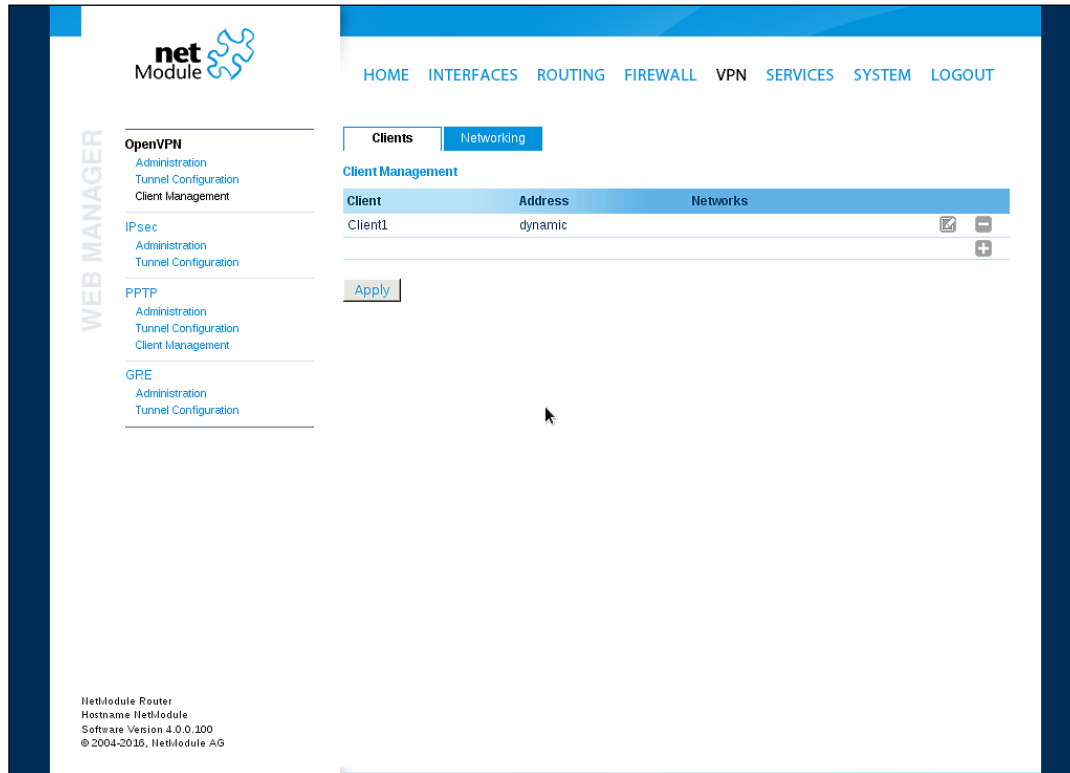

Figure 5.30.: OpenVPN Client Management

In the Networking section you can specify a fixed tunnel endpoint address for each client. Please note that, if you intend to use a fixed address for a particular client, you would have to apply fixed addresses to the other ones as well.

You may specify the network behind the clients as well as the routes to be pushed to each client. This can be useful for routing purposes, e.g. in case you want to redirect traffic for particular networks towards the server. Routing between the clients is generally not allowed but you can enable it if desired.

Finally, you can generate and download all expert mode files for enabled clients which can be used to easily populate each client.

Operating in server mode with certificates, it is possible to block a specific client by revoking a possibly stolen client certificate (see [5.8.8](#)).

5.6.2. IPsec

IPsec is a protocol suite for securing IP communications by authenticating and encrypting each packet of a communication session and thus establishing a secure virtual private network.

IPsec includes various cryptographic protocols and ciphers for key exchange and data encryption and can be seen as one of the strongest VPN technologies in terms of security. It uses the following mechanisms:

| Mechan | Description |
|--------|---|
| AH | Authentication Headers (AH) provide connectionless integrity and data origin authentication for IP datagrams and ensure protection against replay attacks. |
| ESP | Encapsulating Security Payloads (ESP) provide confidentiality, data-origin authentication, connectionless integrity, an anti-replay service and limited traffic-flow confidentiality. |
| SA | Security Associations (SA) provide a secure channel and a bundle of algorithms that provide the parameters necessary to operate the AH and/or ESP operations. The Internet Security Association Key Management Protocol (ISAKMP) provides a framework for authenticated key exchange. |

Negotiating keys for encryption and authentication is generally done by the Internet Key Exchange protocol (IKE) which consists of two phases:

| Phase | Description |
|-------------|--|
| IKE phase 1 | IKE authenticates the peer during this phase for setting up an ISAKMP secure association. This can be carried out by either using <code>main</code> or <code>aggressive</code> mode. The <code>main</code> mode approach utilizes the Diffie-Hellman key exchange and authentication is always encrypted with the negotiated key. The <code>aggressive</code> mode just uses hashes of the pre-shared key and therefore represents a less-secure mechanism which should generally be avoided as it is prone to dictionary attacks. |
| IKE phase 2 | IKE finally negotiates IPsec SA parameters and keys and sets up matching IPsec SAs in the peers which is required for AH/ESP later on. |

Administration

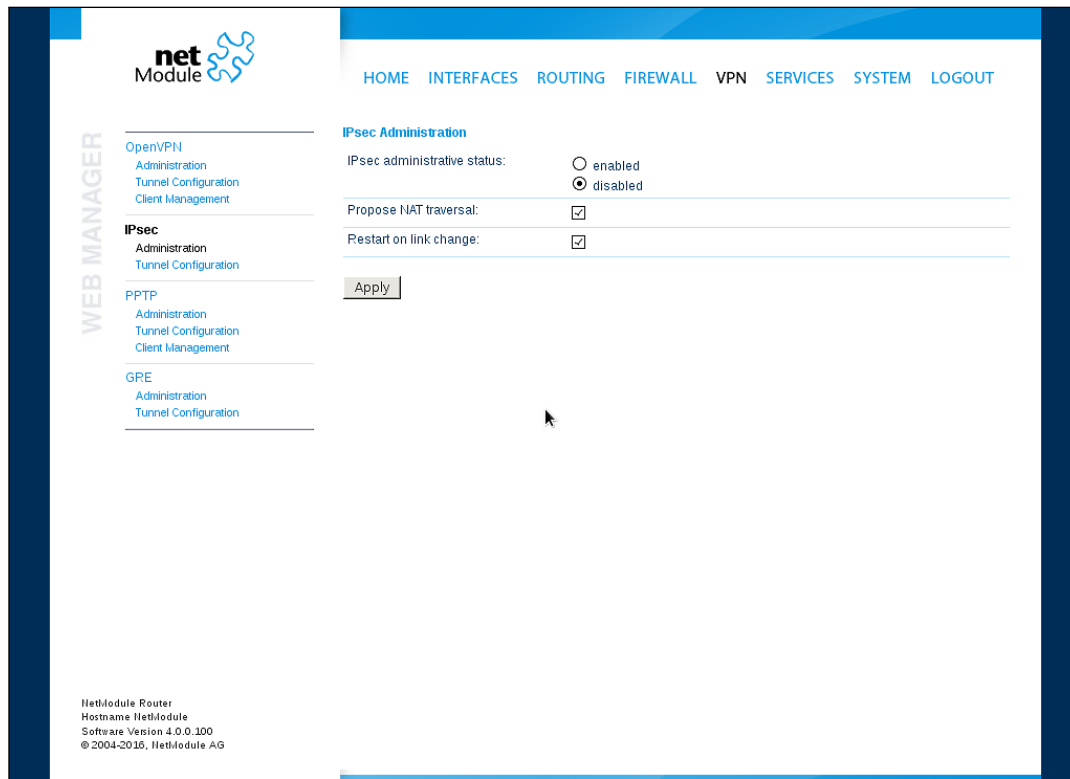

Figure 5.31.: IPsec Administration

This page can be used to enable/disable IPsec, you may also specify whether NAT-Traversal should be used.

NAT-Traversal is mainly used for connections which traverse a path where a router modifies the IP address/port of packets. It encapsulates packets in UDP and therefore requires a slight overhead which has to be taken into account when running over small-sized MTU interfaces.

Please note that running NAT-Traversal makes IKE use UDP port 4500 rather than 500 which has to be taken into account when setting up firewall rules.

Configuration

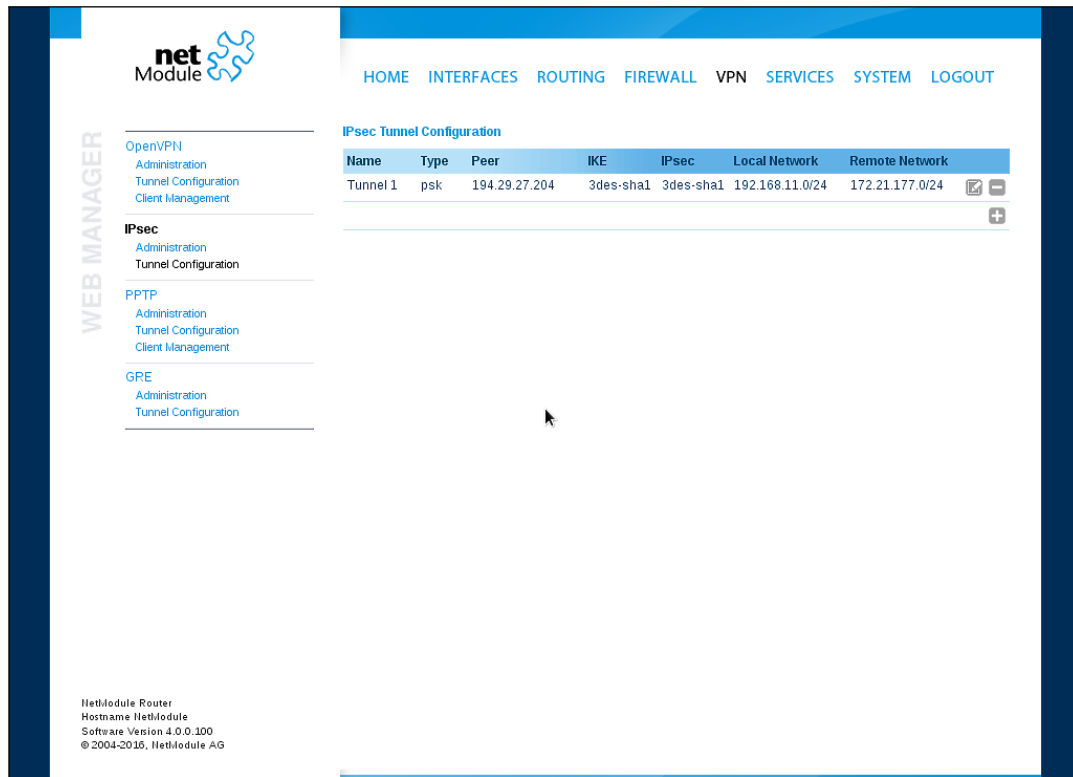

Figure 5.32.: IPsec Configuration

General

For setting up the tunnel you will have to configure the following parameters first:

| Parameter | IPsec General Settings |
|-------------------|--|
| Remote peer | IP address or host name of the remote IPsec peer. You may specify 0.0.0.0 to act as a responder for roadwarrior clients. |
| DPD Status | Specifies whether Dead Peer Detection (see RFC 3706) shall be used. DPD will detect any broken IPsec connections, in particular the ISAKMP tunnel, and refresh the corresponding SAs (Security Associations) and SPIs (Security Payload Identifier) for a faster re-establishment of the tunnel. |
| Detection cycle | The delay (in seconds) between DPD keepalives that are sent for this connection (default 30 seconds) |
| Failure threshold | The number of unanswered DPD requests until the IPsec peer is considered dead (the router will then try to re-establish a dead connection automatically) |

| Parameter | IPsec General Settings |
|-----------|---|
| Action | The action to perform if a peer disconnects. Available choices from the drop-down menu are to clear, hold or to Restart the peer. |

IKE Authentication

NetModule routers support IKE authentication through pre-shared keys (PSK) or certificates within a public key infrastructure. Extended Authentication (XAUTH) leverages RADIUS-like authentication and can be used to apply user level access control over IPsec.

Using PSK requires the following settings:

| Parameter | IPsec IKE Authentication Settings |
|----------------|--|
| PSK | The pre-shared key used to authenticate at the peer |
| Local ID Type | The type of identification for the local ID which can be a FQDN, username@FQDN or IP address |
| Local ID | The local ID value |
| Remote ID Type | The type of identification for the remote ID |
| Remote ID | The remote ID value |

When using certificates you would need to specify the operation mode. When run as PKI client (initiator) you can create a Certificate Signing Request (CSR) in the certificates section which needs to be submitted at your Certificate Authority and imported to the router afterwards. In PKI server mode (concentrator), the router represents the Certificate Authority and issues the certificates for remote peers. They are revokable.

Using XAUTH the following settings can be made:

| Parameter | IPsec XAUTH Settings |
|----------------|--------------------------------|
| User name | The name of the XAUTH user |
| User password | The password of the XAUTH user |
| Group name | The group ID |
| Group password | The group secret |

IKE Proposal

This section can be used to configure the phase 1 settings:

| Parameter | IPsec IKE Proposal Settings |
|--------------------------|--|
| Negotiation mode | Choose the desired negotiation mode. Preferably, <code>main</code> mode should be used but <code>aggressive</code> mode might be applicable when dealing with dynamic endpoint addresses. |
| Encryption algorithm | The desired IKE encryption method (we recommend AES256) |
| Authentication algorithm | The desired IKE authentication method (we prefer SHA1 over MD5) |
| IKE Diffie-Hellman Group | The IKE Diffie-Hellman Group |
| SA life time | The lifetime of Security Associations |
| Perfect Forward Secrecy | Specifies whether Perfect Forward Secrecy (PFS) should be used. This feature increases security as PFS avoids penetration of the key-exchange protocol and prevents compromise of previous keys. |
| Pseudo-random function | PRF algorithms that can optionally be used. |

IPsec Proposal

This section can be used to configure the phase 2 settings:

| Parameter | IPsec Proposal Settings |
|-------------------------------|--|
| Encapsulation mode | The desired encapsulation mode (Tunnel or Transport) |
| IPsec protocol | The desired IPsec protocol (AH or ESP) |
| Encryption algorithm | The desired IKE encryption method (we recommend AES256) |
| Authentication algorithm | The desired IKE authentication method (we prefer SHA1 over MD5) |
| SA life time | The lifetime of Security Associations |
| Perfect forward secrecy (PFS) | Specifies whether Perfect Forward Secrecy (PFS) should be used. This feature increases security as PFS avoids penetration of the key-exchange protocol and prevents compromise of previous keys. |
| Force encapsulation | Force UDP encapsulation for ESP packets even if no NAT situation is detected. |

Networks

When creating Security Associations, IPsec will keep track of routed networks within the tunnel. Packets will be only transmitted when a valid SA with matching source and destination network is present. Therefore, you may need to specify the networks right and left of the endpoints by applying the following settings:

| Parameter | IPsec Network Settings |
|---------------|---|
| Local network | The address of your local area network |
| Local netmask | The netmask of your local area network |
| Peer network | The address of the remote network behind the peer |
| Peer netmask | The netmask of the remote network behind the peer |
| NAT address | Optionally, you can apply NAT (masquerading) for packets coming from a different local network. The NAT address must reside in the network previously specified as local network. |

Client Management

Once you have successfully set up an IPsec tunnel, you can manage and enable clients connecting to your service. It is possible to generate and download expert mode files for enabled clients which can be used to easily populate each client.

5.6.3. PPTP

The Point-to-Point Tunneling Protocol (PPTP) is a method for implementing virtual private networks between two hosts. PPTP is easy to configure and widely deployed amongst Microsoft Dial-up networking servers. However, due to its weak encryption algorithms, it is nowadays considered insecure but it still provides a straightforward way for establishing tunnels.

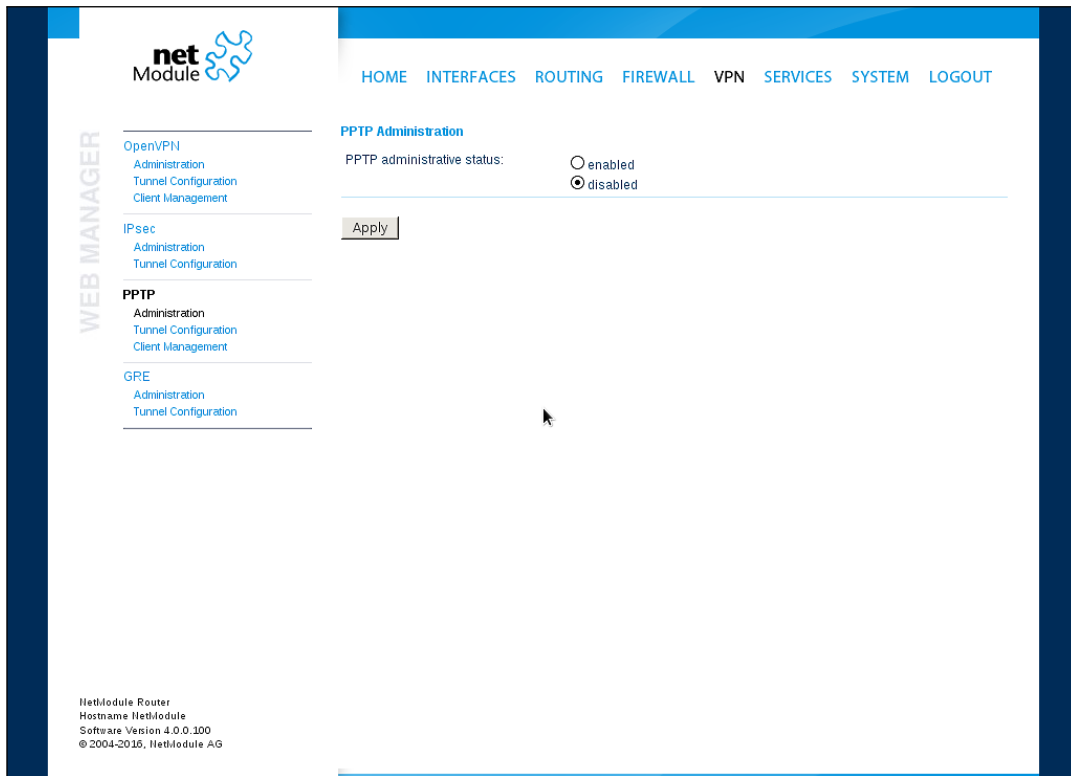

Figure 5.33.: PPTP Administration

When setting up a PPTP tunnel, you would need to choose between server or client. A client tunnel requires the following parameters to be set:

| Parameter | PPTP Client Settings |
|----------------|---------------------------------------|
| Server address | The address of the remote server |
| Username | The user-name used for authentication |
| Password | The password used for authentication |

Please note that username and password are not used when setting up clients with fixed addresses.

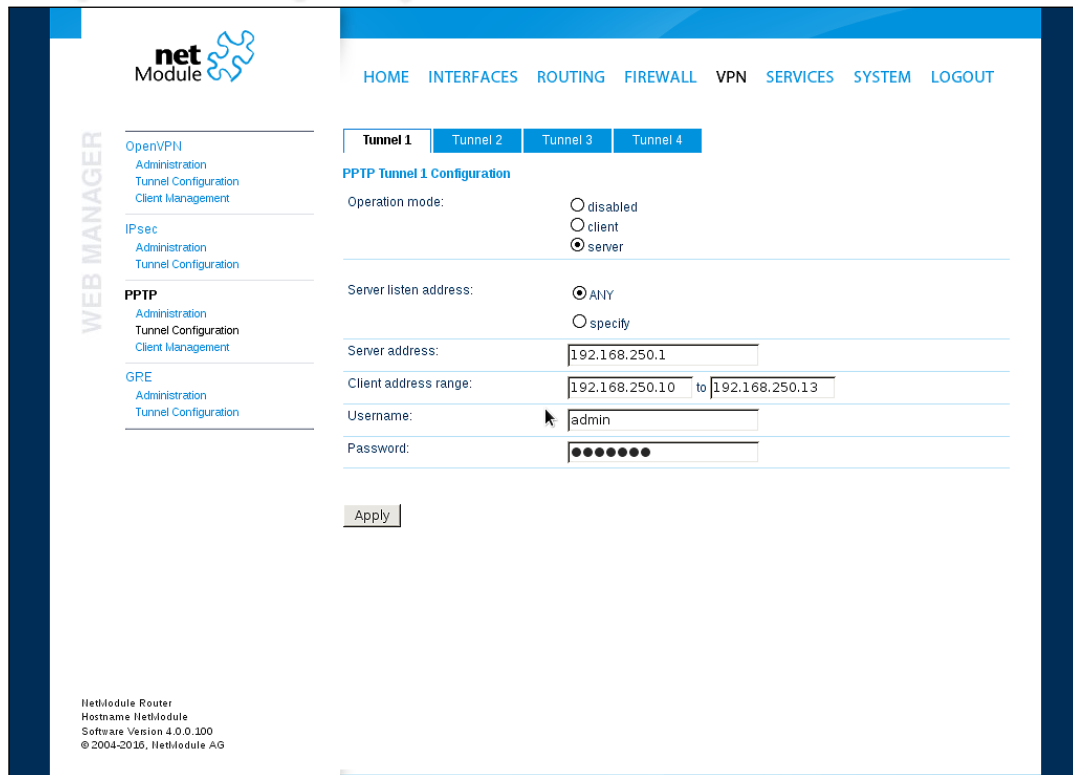

Figure 5.34.: PPTP Tunnel Configuration

Setting up a server requires the following settings:

| Parameter | PPTP Server Settings |
|----------------------|--|
| Listen address | Specifies on which IP address should be listened for incoming client connections |
| Server address | The server address within the tunnel |
| Client address range | Specifies a range of IP addresses assigned to each client |

PPTP Client Management

PPTP clients for a server tunnel need to be configured here. They are made up of user-name and password. A fixed IP address can be assigned to them which can be used to point any routes to a dedicated tunnel.

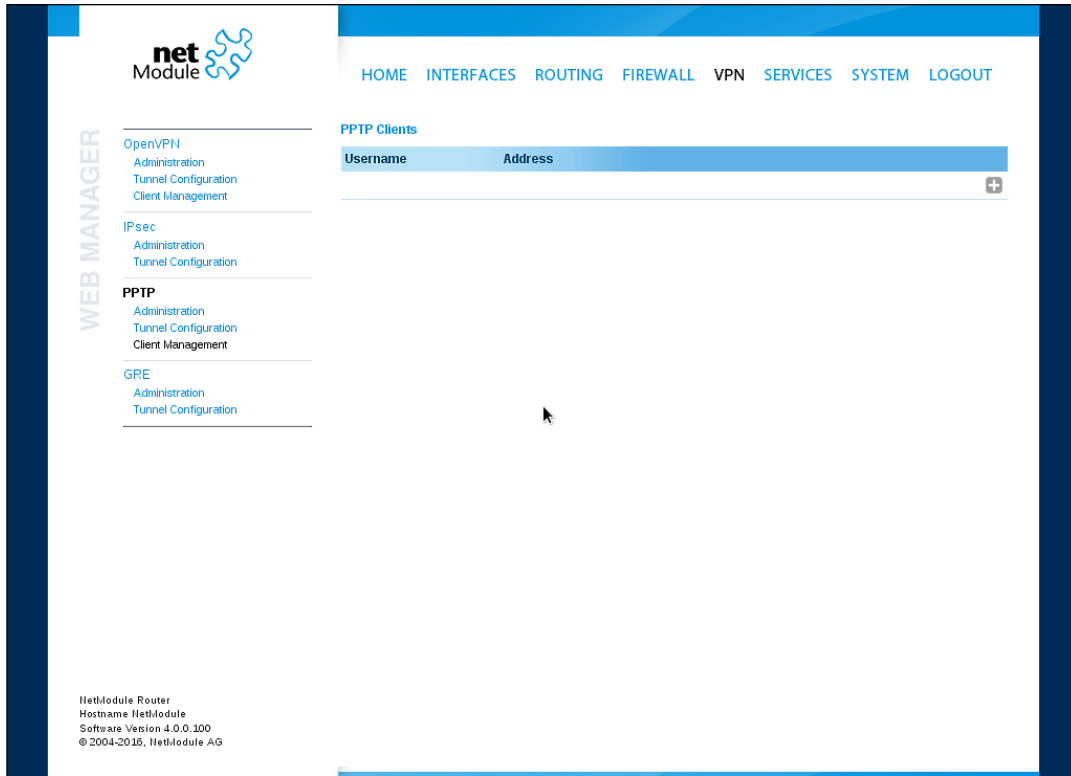

Figure 5.35.: PPTP Client Management

5.6.4. GRE

The Generic Routing Encapsulation (GRE) is a tunneling protocol that can encapsulate a wide variety of network layer protocols inside virtual point-to-point links over IP. GRE is defined in RFC 1701, 1702 and 2784. It does not provide encryption nor authorization but can be used on an address-basis on top of other VPN techniques (such as IPsec) for tunneling purposes. The following parameters are required for setting up a tunnel:

| Parameter | GRE Configuration |
|----------------------|--|
| Peer address | The IP address of the remote peer |
| Interface | The device type for this tunnel |
| Local tunnel address | The local IP address of the tunnel |
| Local tunnel netmask | The local subnet mask of the tunnel |
| Remote network | The remote network address of the tunnel |
| Remote netmask | The remote subnet mask of the tunnel |

In general, the local tunnel address/netmask should not conflict with any other interface addresses. The remote network/netmask will result in an additional route entry in order to control which packets should be encapsulated and transferred over the tunnel.

5.6.5. Dial-In

On this page you can configure the Dial-In server in order to establish a data connection over GSM calls. Thus, one would generally apply a required service type of 2G-only, so that the modem registers to GSM only. Naturally, a concurrent use of outgoing WWAN interfaces and Dial-In connection is not possible.

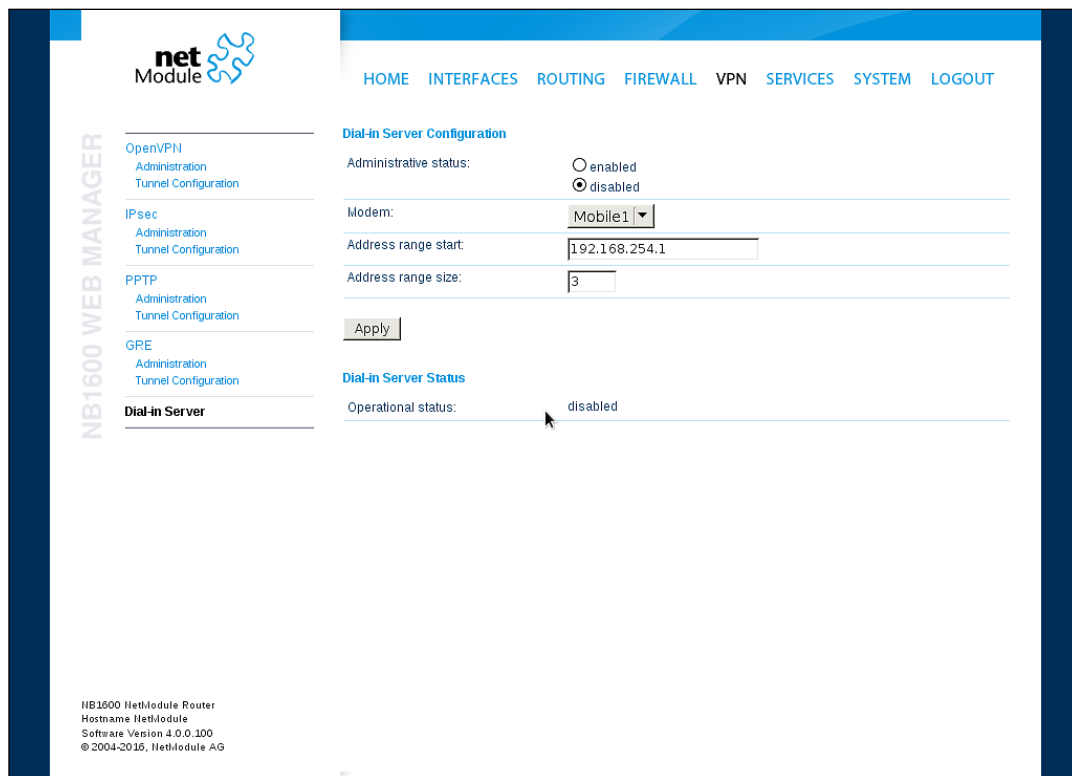

Figure 5.36.: Dial-in Server Settings

The following settings can be set:

| Parameter | Dial-in Server Configuration |
|-----------------------|--|
| Administrative status | Specifies whether incoming calls shall be answered or not |
| Modem | Specifies the modem on which calls can come in |
| Address range start | Start of the IP address range assigned to incoming clients |
| Address range size | Number of addresses for client IP address range |

The PPP dial-in connection is validated by username admin and the administrator password. Please note that Dial-In connections are generally discouraged. As they are implemented as GSM voice calls, they suffer from unreliability and poor bandwidth.

5.7. SERVICES

5.7.1. SDK

NetModule routers are shipping with a Software Development Kit (SDK) which offers a simple and fast way to implement customer-specific functions and applications. It consists of:

1. An SDK host which defines the runtime environment (a so-called sandbox), that is, controlling access to system resources (such as memory, storage and CPU) and, by doing so, catering for the right scalability
2. An interpreter language called `arena`, a light-weight scripting language optimized for embedded systems, which uses a syntax similar to ANSI-C but adds support for exceptions, automatic memory management and runtime polymorphism on top of that
3. A NetModule-specific Application Programming Interface (API), which ships with a comprehensive set of functions for accessing hardware interfaces (e.g. digital IO ports, GPS, external storage media, serial ports) but also for retrieving system status parameters, sending E-Mail or SMS messages or simply just to configure the router

Anyone, reasonably experienced in the C language, will find an environment that is easy to dig in. However, feel free to contact us via router@support.netmodule.com and we will happily support you in finding a programming solution to your specific problem.

The Language

The `arena` scripting language offers a broad range of POSIX functions (like `printf` or `open`) and provides, together with tailor-made API functions, a simple platform for implementing any sort of applications to interconnect your favourite device or service with the router.

Here comes a short example:

```
/* We are going to eavesdrop on the first serial port
 * and turn on lights via a digital I/O output port,
 * otherwise we'd have to send a short message.
 */

for (attempts = 0; attempts < 3; attempts++) {
    if (nb_serial_read("serial0") == "Knock Knock!") {
        nb_serial_write("serial0", "Who's there?");

        if (nb_serial_read("serial0") == "Santa") {
            printf("Hurray!\n");
            nb_dio_set("out1", 1);
        }
    }
}
nb_sms_send("+123456789", "No presents this year :(")
```

A set of example scripts can be downloaded directly from the router, you can find a list of them in the appendix. The manual which can be obtained from the [NetModule support web page](#) gives a detailed introduction of the language, including a description of all available functions.

SDK API Functions

The current range of API functions can be used to implement the following features:

1. Send/Retrieve SMS
2. Send E-mail
3. Read/Write from/to serial device
4. Control digital input/output ports
5. Run TCP/UDP servers
6. Run IP/TCP/UDP clients
7. Access files of mounted media (e.g. an USB stick)
8. Retrieve status information from the system
9. Get or set configuration parameters
10. Write to syslog
11. Transfer files over HTTP/FTP
12. Perform config/software updates
13. Control the LEDs
14. Get system events, restart services or reboot system
15. Scan for networks in range
16. Create your own web pages
17. Voice control functions
18. SNMP functions
19. CAN socket functions
20. Various network-related functions
21. Other system-related functions

The SDK API manual (which can be downloaded from the router) provides an overview but also explains all functions in detail.

Please note that some functions require the corresponding services (e.g. E-Mail, SMS) or configured interfaces (e.g. CAN) to be properly configured prior to utilizing them in the SDK.

Let's now pay some attention to the very powerful API function `nb_status`. It can be used to query the router's status values in the same manner as they can be shown with the CLI. It returns a structure of variables for a specific section (a list of available sections can be obtained by running `cli status -h`).

By using the `dump` function you can figure out the content of the returned structure:

```
/* dump current location */
dump(nb_status("location"));
```

The script will then generate lines like maybe these:

```
struct(8): {
  .LOCATION_STREET      = string[11]: "Bahnhofquai"
  .LOCATION_CITY        = string[10]: "Zurich"
  .LOCATION_COUNTRY_CODE = string[2]: "ch"
  .LOCATION_COUNTRY     = string[11]: "Switzerland"
  .LOCATION_POSTCODE    = string[4]: "8001"
  .LOCATION_STATE       = string[6]: "Zurich"
  .LOCATION_LATITUDE    = string[9]: "47.3778058"
  .LOCATION_LONGITUDE   = string[8]: "8.5412757"
}
```

In combination with the `nb_config_set` function, it is possible to start a re-configuration of any parts of the system upon status changes. You may query possible sections and parameters again with the CLI:

```
~ $ cli get -c wanlink.0
cli get -c wanlink.0
Showing configuration entities (matching 'wanlink.0'):
```

```
wanlink.0.mode          wanlink.0.multipath    wanlink.0.name
wanlink.0.options      wanlink.0.passthru     wanlink.0.prio
wanlink.0.suspend      wanlink.0.switchback   wanlink.0.weight
```

Running the CLI in interactive mode, you will be also able to step through possible configuration parameters by the help of the TAB key.

Here is an example how one might adopt those functions:

```
/* check current city and enable the second WAN link */  
  
location = nb_status("location");  
if (location) {  
    city = struct_get(location, "LOCATION_CITY");  
  
    if (city == "Wonderland") {  
        for (led = 0; led < 5; led++) {  
            nb_led_set(led, LED_BLINK_FAST|LED_COLOR_RED);  
        }  
    } else {  
        printf("You'll never walk alone in %s ...\n", city);  
        nb_config_set("wanlink.1.mode=1");  
    }  
}
```

Running SDK

In the SDK, we are speaking of `scripts` and `triggers` which form `jobs`.

Any arena script can be uploaded to the router or imported by using dedicated user configuration packages. You may also edit the script directly at the Web Manager or select one of our examples. You will further have a testing section on the router which can be used to check your syntax or doing test runs.

Once uploaded, you will have to specify a trigger, that is, telling the router when the script is to be executed. This can be either time-based (e.g. each Monday) or triggered by one of the pre-defined system events (e.g. wan-up) as described in Events chapter 5.7.7. With both, a script and a trigger, you can finally set up an SDK job now. The `test` event usually serves as a good facility to check whether your job is doing well. The admin section also offers facilities to troubleshoot any issues and control running jobs.

The SDK host (`sdkhost`) corresponds to the daemon managing the scripts and their operations and thus avoiding any harm to the system. In terms of resources, it will limit CPU and memory for running scripts and also provide a pre-defined portion of the available space of the storage device. You may, however, extend it by external USB storage or (depending on your model) extended flash storage.

Files written to `/tmp` will be hold in memory and will be cleared upon a restart of the script. As your scripts operate in the sandbox, you will have no access to tools on the system (such as `ifconfig`).

Administration

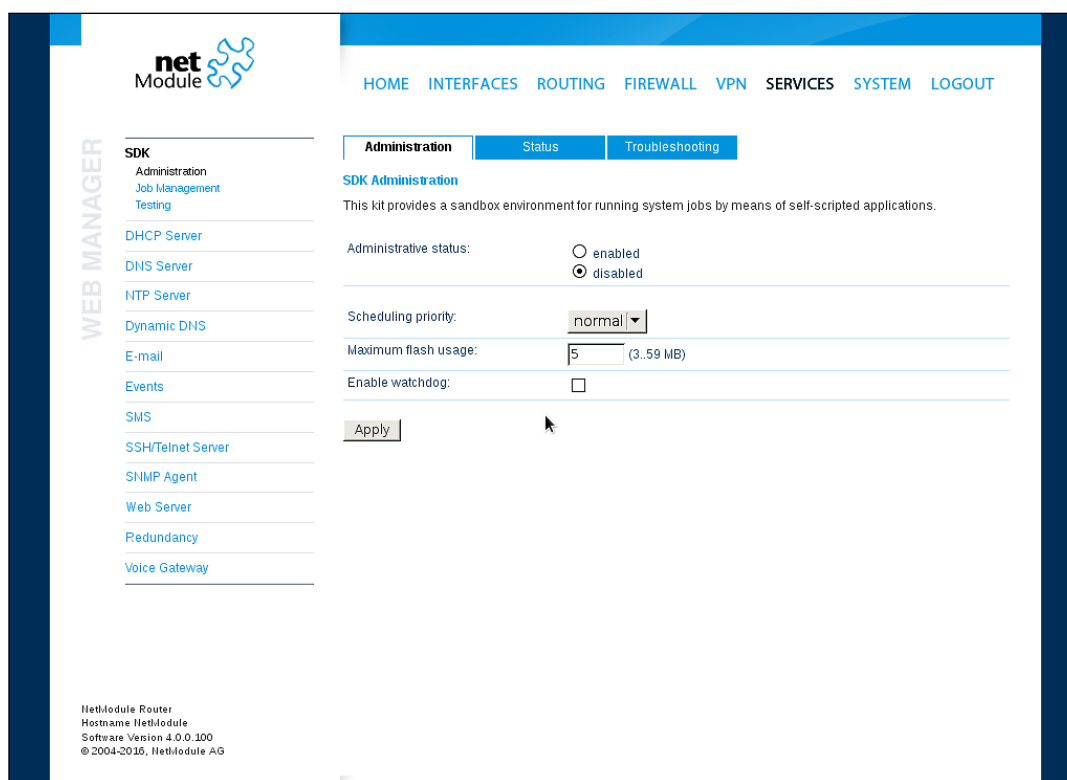

Figure 5.37.: SDK Administration

This page can be used to control the SDK host and apply the following settings:

| Parameter | SDK Administration Settings |
|-----------------------|--|
| Administrative status | Specifies whether SDK scripts should run or not |
| Storage | The storage device on which the sandbox shall be stored (see chapter 5.8.1) |
| Max. size | The maximum amount of MBytes your scripts can consume on the storage device |
| Scheduling priority | Specifies the process priority of the sdkhost, higher priorities will speed up scheduling your scripts, lower ones will have less impact to the host system |
| Enable watchdog | This option will enable watchdog supervision for each script which leads to a reboot of the system if the script does not respond or stopped with an exit code not equal zero. |

The status page informs you about the current status of the SDK. It provides an overview about any finished jobs, you can also stop a running job there and view the script output in the troubleshooting section where you will also find links for downloading the manuals and examples.

Job Management

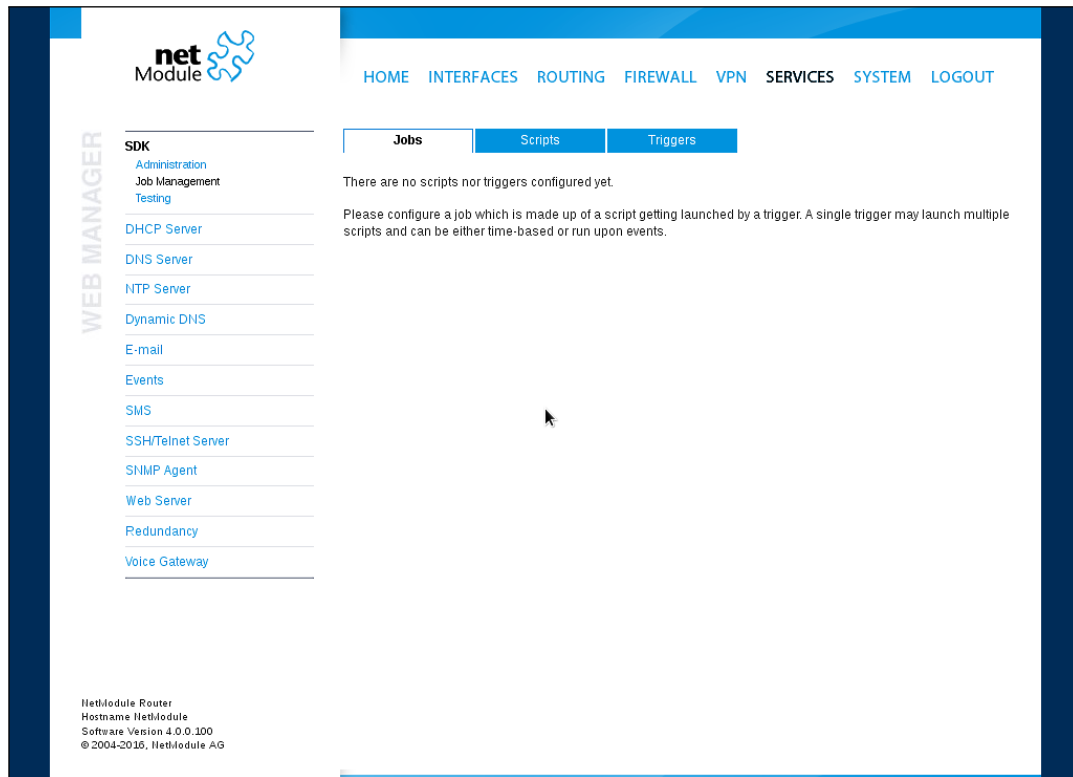

Figure 5.38.: SDK Jobs

This page can be used to set up scripts, triggers and jobs. It is usually a good idea to create a trigger first which is made up by the following parameters:

| Parameter | SDK Trigger Parameters |
|-----------|--|
| Name | A meaningful name to identify the trigger |
| Type | The type of the trigger, either time-based or event-based |
| Condition | Specifies the time condition for time-based triggers (e.g. hourly) |
| Timespec | The time specification which, together with the condition, specifies the time(s) when the trigger should be pulled |
| Event | The system event upon which the trigger should be pulled |

You can now add your personal script to the system by applying the following parameters:

| Parameter | SDK Script Parameters |
|-------------|--|
| Name | A meaningful name to identify the script |
| Description | An optional description of the script |

| Parameter | SDK Script Parameters |
|-----------|--|
| Arguments | An optional set of arguments passed to the script (supports quoting) |
| Action | You may either edit a script, upload it to the system or select one of the example scripts or an already uploaded script |

You are ready to set up a job afterwards, it can be created by using the following parameters:

| Parameter | SDK Job Parameters |
|-----------|---|
| Name | A meaningful name to identify the job |
| Trigger | Specifies the trigger that should launch the job |
| Script | Specifies the script to be executed |
| Arguments | Defines arguments which can be passed to the script (supports quoting), they will precede the arguments you formerly may have assigned to the script itself |

You can trigger each configured job directly which can be helpful for testing purposes.

Pages

Any programmed SDK pages will show up here.

Testing

The testing page offers an editor and an input field for optional arguments which can be used to perform test runs of your script or test dedicated portions of it or upload an entire file. Please note that you might need to quote arguments as they will otherwise be separated by white-spaces.

```
/* arguments: 'schnick schnack "s c h n u c k"'
for (i = 0; i < argc; i++) {
    printf("argv%d: %s\n", i, argv[i]);
}

/* generates:
*     argv0: scriptname
*     argv1: schnick
*     argv2: schnack
*     argv3: s c h n u c k
*/
```

In case of syntax errors, arena will usually print error messages as follows (indicating the line and position where the parsing error occurred):

```
/scripts/testrun:2:10:FATAL: parse error, unexpected $, expecting ';''
```

SDK Sample Application

As an introduction, you can step through a sample application, namely the SMS control script, which implements remote control over short messages and can be used to send a status of the system back to the sender. The source code is listed in the appendix.

Once enabled, you can send a message to the phone number associated with a SIM / modem. It generally requires a password to be given on the first line and a command on the second, such as:

```
admin01
status
```

We strongly recommend to use authentication in order to avoid any unintended access, however you may pass `noauth` as argument to disable it. You can then skip the first line containing the password. Having a closer look to the script, you will see that you will also be able to restrict the list of permitted senders. Please inspect the system log for troubleshooting any issues.

The following commands are supported:

| Command | Action |
|--------------|--|
| status | Will reply a message to the sender including a short system overview |
| connect | Will enable the first WAN link configured on the system |
| disconnect | Will disable the first WAN link configured on the system |
| reboot | Initiates a reboot of the system |
| output 1 on | Turns on the first digital output port |
| output 1 off | Turns off the first digital output port |
| output 2 on | Turns on the second digital output port |
| output 2 off | Turns off the second digital output port |

Table 5.89.: SMS Control Commands

A response to the status command typically looks like:

```
System: NB2700 hostname (00:11:22:AA:BB:CC)
WAN1: WWAN1 is up (10.0.0.1, Mobile1, UMTS, -83 dBm, LAI 12345)
GPS: lat 47.377894, lon 8.540055, alt 282.200
OVPN: client on tun0 is up (10.0.8.4)
DIO: IN1=off, IN2=off, OUT1=on, OUT2=off
```

5.7.2. DHCP Server

This section can be used to individually configure the Dynamic Host Configuration Protocol (DHCP) service for each LAN interface which will serve dynamic IP addresses to hosts in the local network. You may also have a look to the status page where you can find an overview about negotiated client addresses.

Please note that WLAN interfaces (for each SSID) will pop up here as well in case you have configured an access point respectively.

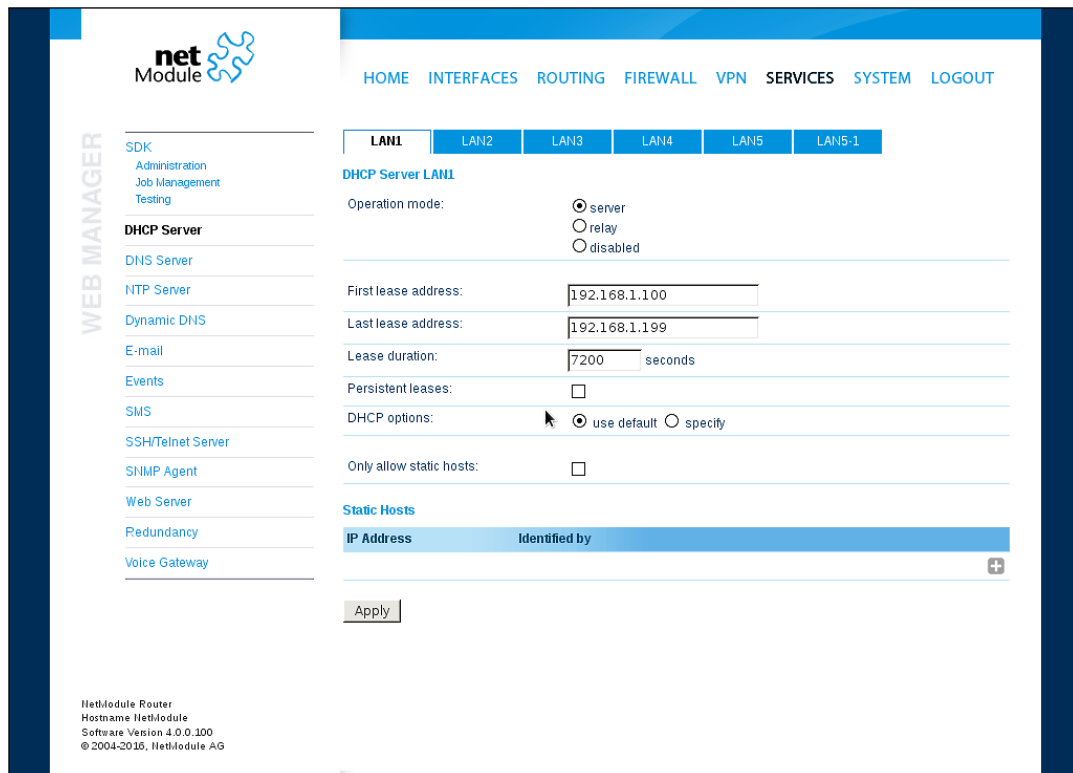

Figure 5.39.: DHCP Server

The following settings for each interface can be applied then:

| Parameter | DHCP Server Settings |
|---------------------|--|
| Operation mode | Specifies whether the DHCP server is enabled or not |
| First lease address | The first address out of the range of IP addresses given to hosts |
| Last lease address | The last address out of this range |
| Lease duration | Number of seconds how long a given lease shall be valid until it has to be requested again |

| Parameter | DHCP Server Settings |
|-------------------------|--|
| Persistent leases | By turning on this option the router will remember issued leases even after a reboot. This can be used to ensure that the same IP address will be assigned to a particular host. |
| DHCP options | By default the DHCP will hand out the interface address as default gateway and the current DNS server addresses if not configured elsewhere. You can specify fixed addresses here. |
| Only allow static hosts | Any requests coming from none-static hosts will be ignored. |

It is also possible to configure specific lease addresses for particular clients.

| Parameter | DHCP Static Hosts Settings |
|---------------|--|
| IP address | The IP address of the lease |
| Identified by | Specifies by which criteria the client shall be identified |
| MAC address | The MAC address of the client |
| hostname | The client identifier (DHCP option 61) |
| port | The Ethernet port on which the DHCP request is received |

5.7.3. DNS Server

The DNS server can be used to proxy DNS requests towards servers on the net which have for instance been negotiated during WAN link negotiation. By pointing DNS requests to the router, one can reduce outbound DNS traffic as it is caching already resolved names but it can be also used for serving fixed addresses for particular host names.

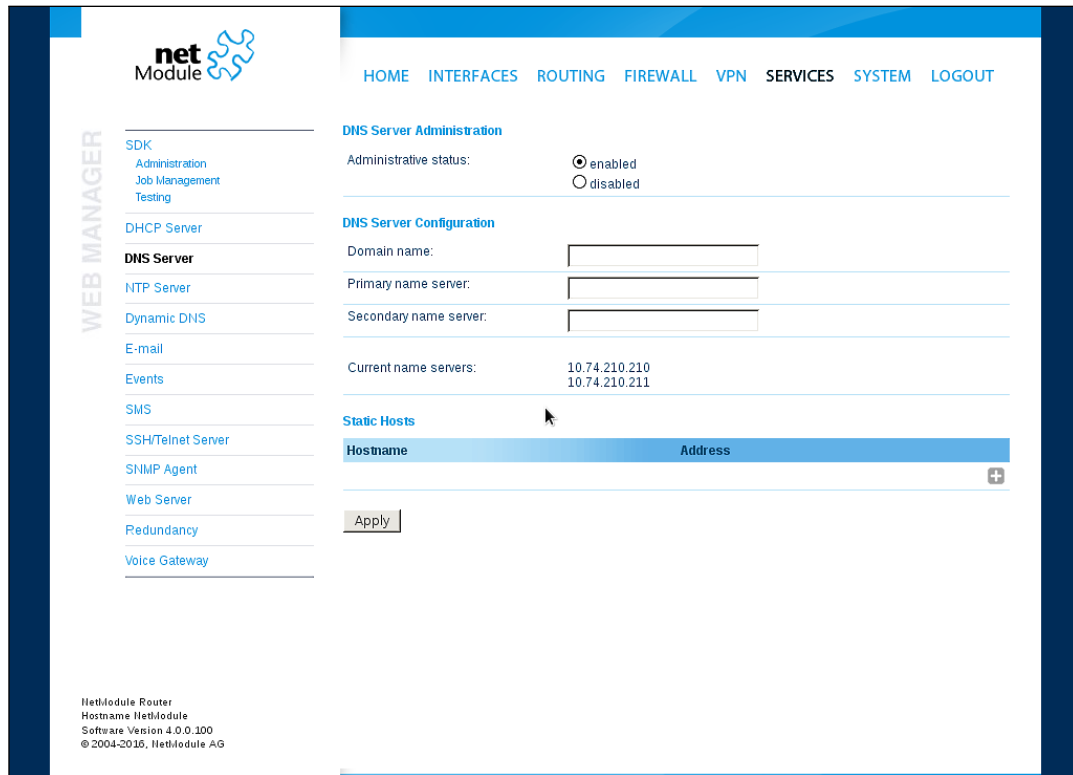

Figure 5.40.: DNS Server

The following settings can be applied:

| Parameter | DNS Server Settings |
|-----------------------|---|
| Administrative status | Enables or disables the DNS server |
| Domain name | The domain name used for short name lookups |
| Primary name server | The primary default name server which will be used instead of negotiated name servers |
| Secondary name server | The secondary default name server which will be used instead of negotiated name servers |

You may further configure static hosts for serving fixed IP addresses for various host names.

| Parameter | DNS Static Hosts Settings |
|-----------|-----------------------------------|
| Address | The IP address of the static host |
| Hostname | The hostname of the static host |

Please remember to point DNS lookups of local hosts to the router's address.

5.7.4. NTP Server

This section can be used to individually configure the Network Time Protocol (NTP) server function.

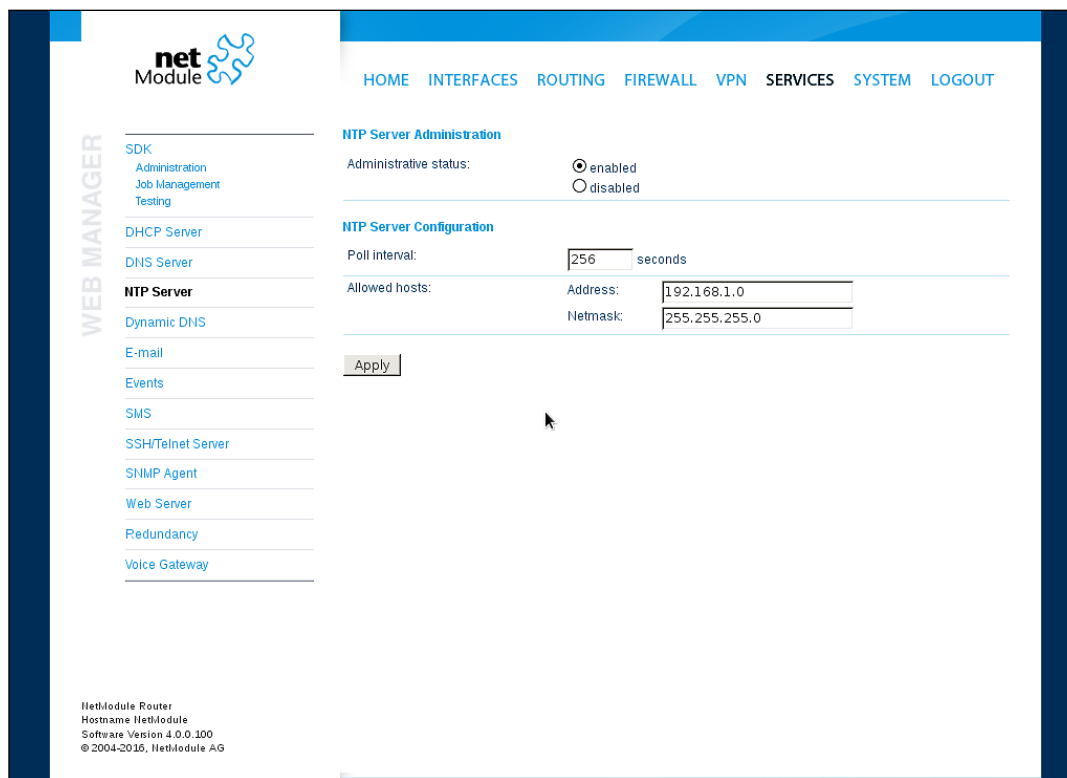

Figure 5.41.: NTP Server

The following settings for each interface can be applied then:

| Parameter | NTP Server Settings |
|-----------------------|--|
| Administrative status | Specifies whether the NTP server is enabled or not |
| Poll interval | Defines the polling interval (64..2048 seconds) for synchronizing the time with the master clock servers |
| Allowed hosts | Defines the IP address range which is allowed to poll the NTP server |

For setting the system time of the device see [5.8.1](#).

5.7.5. Dynamic DNS

The Dynamic DNS client can be used to tell one or multiple DynDNS providers the current IP address of your system. This address can be derived from the current hotlink interface or the outgoing interface which will be used when contacting the server. We further support to ask the CheckIP service at dyndns.org for obtaining the current Internet address which can be useful in NAT scenarios. The DynDNS client will be triggered whenever a WAN or VPN link comes up.

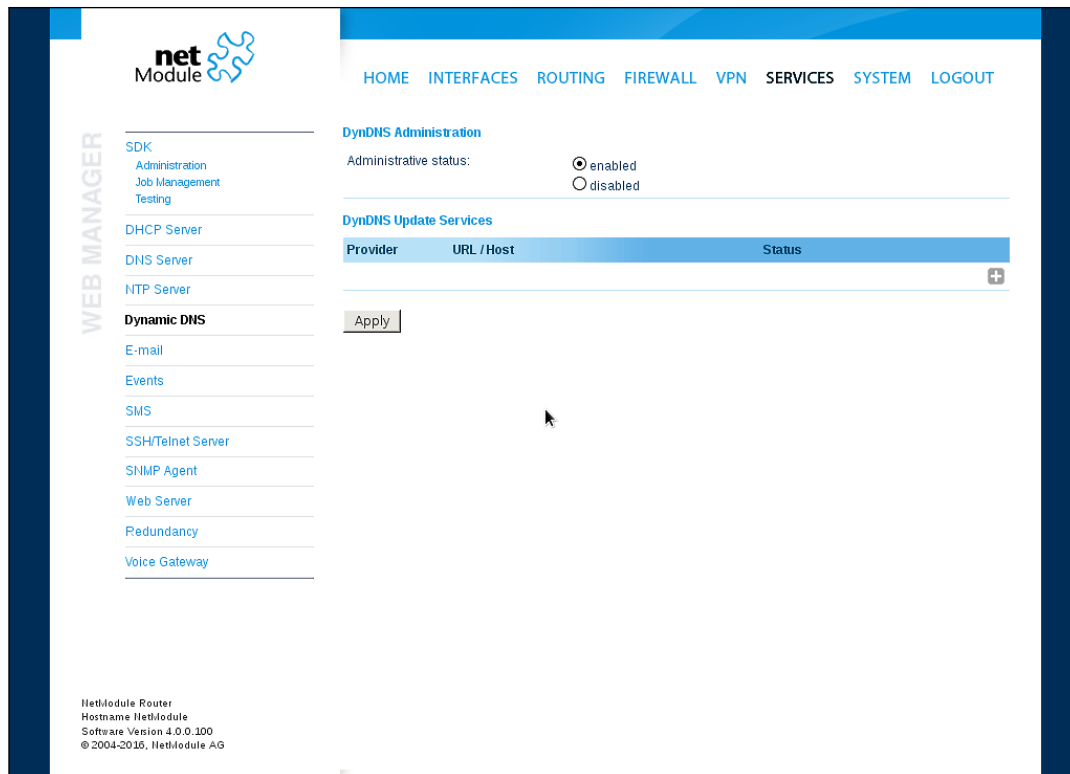

Figure 5.42.: Dynamic DNS Settings

We provide support for a bunch of common DynDNS operators but it is also possible to define a custom update URL.

Please note that your NetModule router can operate as DynDNS server on its own, provided that you have your hosts pointed to the DNS service of the router.

We can further operate the GnuDIP protocol and RFC2136-like dynamic DNS updates. The latter is in general secured by a TSIG key.

A DynDNS service can receive the following parameters:

| Parameter | Dynamic DNS Settings |
|-----------------|---|
| Provider | You can choose one of the listed providers or provide a custom URL |
| Dynamic address | Specifies whether the address is derived from the hot-link or via an external service |
| Hostname | The host-name provided by your DynDNS service (e.g. my-box.dyndns.org) |
| Port | The HTTP port of the service (typically 80) |
| Username | The user-name used for authenticating at the service |
| Password | The password used for authentication |
| Protocol | The protocol used for authentication (HTTP, HTTPS) |
| Server address | The address of the server which shall be updated |
| Server port | The port of the server which shall be updated |
| TSIG key name | The name of the TSIG key which is allowed to perform updates |
| TSIG key | The TSIG key encoded in base64 |

5.7.6. E-Mail

The E-Mail client can be used to send notifications to a particular E-Mail address upon certain events or by SDK scripts.

The screenshot displays the NetModule WEB MANAGER interface. The left sidebar lists various configuration options, with 'E-mail' selected. The main content area shows the 'E-mail Client Configuration' page under the 'Configuration' tab. The settings are as follows:

- Administrative status:** enabled, disabled
- From address:** router@netmodule.com
- Server address:** mail.netmodule.com
- Server port:** 25
- Authentication:** automatic (dropdown menu)
- Encryption:** tls (dropdown menu)
- Username:** router@netmodule.com
- Password:** [masked with dots]

An 'Apply' button is located at the bottom of the configuration form. The footer of the interface indicates: NetModule Router, Hostname: NetModule, Software Version 4.0.0.100, ©2004-2015, NetModule AG.

Figure 5.43.: E-Mail Settings

It can be enabled by applying the following settings.

| Parameter | E-Mail Client Settings |
|-----------------------|--|
| E-mail client status | Administrative status of the E-Mail client |
| From e-mail address | E-Mail address of the sender |
| Server address | SMTP server address |
| Server port | SMTP server port (typically 25) |
| Authentication method | Select the required authentication method which will be used to authenticate against the SMTP server |
| Encryption | Select the encryption. Can be tls or none. |
| Username | User name used for authentication |
| Password | Password used for authentication |

5.7.7. Events

By using the event manager you can notify remote systems about system events. A notification can be sent using E-Mail, SMS or SNMP traps.

| Parameter | Event Notification Settings |
|----------------|--|
| E-Mail address | The E-Mail address to which the notification shall be sent (E-Mail client must be enabled) |
| Phone number | The phone number to which the notification shall be sent (SMS service must be enabled) |
| SNMP host | The SNMP host or address to which the trap shall be sent |
| SNMP port | The port of the remote SNMP service |
| Username | The username for accessing the remote SNMP service |
| Password | The password for accessing the remote SNMP service |
| Authentication | The authentication algorithm for accessing the remote SNMP service (MD5 or SHA) |
| Encryption | The encryption algorithm for accessing the remote SNMP service (DES or SHA) |
| Engine ID | The engine ID of the remote SNMP service |

The messages will contain a description provided by you and a short system information. A list of all system events can be found in the appendix [A.2](#).

5.7.8. SMS

Administration

NetModule routers can receive or send short messages (SMS) if enabled by your SIM provider. Messages are received/sent by the modem which has been assigned to a SIM, so one has to properly configure a SMS-capable default modem as described in chapter 5.3.3.

Please note that the system may switch SIMs in case you are running multiple WWAN interfaces sharing the same SIM. Thus, it may happen that a different modem will be used for communication or, if the SIM is unassigned, any operation will even stop.

Please do not forget that modems might register roaming to foreign networks where other fees may apply. You can manually assign a fixed network (by LAI) in the Mobile SIMs section (see 5.3.3).

Sending messages heavily depends on the registration state of the modem and whether the provided SMS Center service works and may fail. You may use the `sms-report-received` event to figure out whether a message has been successfully sent.

Received messages are pulled from the SIMs and temporarily stored on the router but get cleared after a system reboot. Please consider to consult an SDK script in case you want to process or copy them.

The screenshot shows the NetModule Web Manager interface. The main content area is titled 'SMS Administration' and includes the following configuration options:

- Administrative status: enabled, disabled
- Request delivery report: enabled, disabled

Below these options is a table titled 'Activated SIMs':

| SIM | Gateway | Modem | State | Registered |
|------|---------------|---------|-------|------------|
| SIM1 | +491722270333 | Mobile2 | ready | yes |
| SIM2 | +491796865646 | Mobile1 | ready | yes |
| SIM3 | | none | | no |
| SIM4 | | none | | no |

An 'Apply' button is located below the table. The sidebar on the left contains a 'WEB MANAGER' menu with links for SDK, DHCP Server, DNS Server, NTP Server, Dynamic DNS, E-mail, Events, SMS, SSH/Telnet Server, SNMP Agent, Web Server, Redundancy, and Voice Gateway. The bottom left corner of the interface displays: 'NetModule Router, Hostname NetModule, Software Version 4.0.0.100, © 2004-2016, NetModule AG'.

Figure 5.44.: SMS Configuration

The relevant page can be used to enable the SMS service and specify on which it should operate. We identify SIMs based on their IMEI number and track their statistics in a non-volatile manner.

| Parameter | SMS SIM Configuration |
|-------------|--|
| SMS gateway | The service center number for sending short messages. It is generally retrieved automatically from your SIM card but you may define a fix number here. |

Routing & Filtering

By using SMS routing you can specify outbound rules which will be applied whenever message are sent. On the one hand, you can forward them to an enabled modem. For a particular number, you can for instance enforce messages being sent over a dedicated SIM. Phone numbers can also be specified by regular expressions, here are some examples:

| Number | Result |
|-----------|--|
| +12345678 | Specifies a fixed number |
| +1* | Specifies any numbers starting with +1 |
| +1*9 | Specifies any numbers starting with +1 and ending with 9 |
| +12]* | Specifies any numbers starting with either +1 or 2 |

Table 5.99.: SMS Number Expressions

Please note that numbers have to be entered in international format including a valid prefix. On the other hand, you can also define rules to drop outgoing messages, for instance, when you want to avoid using any expensive service or international numbers.

Both types of rules form a list will be processed by order, forwarding outgoing messages over the specified modem or dropping them. Messages which are not matching any of the rules below will be dispatched to the first available modem.

Filtering serves a concept of firewalling incoming messages, thus either dropping or allowing them on a per-modem basis. The created rules are processed by order and in case of matches will either drop or forward the incoming message before entering the system. All non-matching messages will be allowed.

Status

The status page can be used to the current modem status and get information about any sent or received messages. There is a small SMS inbox reader which can be used to view or delete the messages. Please note that the inbox will be cleared each midnight in case it exceeds 512 kBytes of flash usage.

Testing

This page can be used to test whether SMS sending in general or filtering/routing rules works. The maximum length per message part is limited to 160 characters, we also suggest to exclusively use characters which are supported by the GSM 7-bit alphabet.

5.7.9. SSH/Telnet Server

Apart from the Web Manager, the SSH and Telnet services can be used to log into the system. Valid users include *root* and *admin* as well as additional users as they can be created in the User Accounts section. Please note, that a regular system shell will only be provided for the *root* user, the CLI will be launched for any other user whereas normal users will only be able to view status values, the *admin* user will obtain privileges to modify the system.

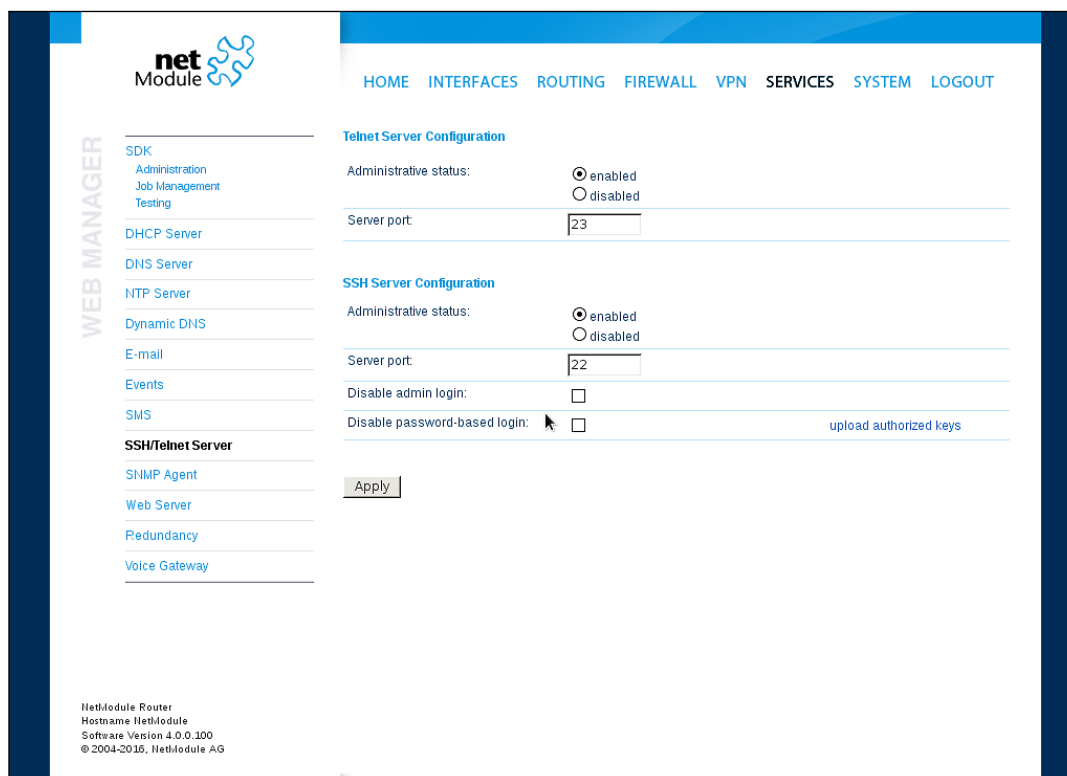

Figure 5.45.: SSH and Telnet Server

Please note that these services will be accessible from the WAN interface also. In doubt, please consider to disable or restrict access to them by applying applicable firewall rules. The following parameters can be applied to the Telnet service:

| Parameter | Telnet Server Settings |
|-----------------------|---|
| Administrative status | Whether the Telnet service is enabled or disabled |
| Server port | The TCP port of the service (usually 23) |

The following parameters can be applied to the SSH service:

| Parameter | SSH Server Settings |
|------------------------------|---|
| Administrative status | Whether the SSH service is enabled or disabled |
| Server port | The TCP port of the service (usually 22) |
| Disable admin login | Disable login for admin users |
| Disable password-based login | By turning on this option, all users will have to authenticate by SSH keys which can be uploaded to the router. |

5.7.10. SNMP Agent

NetModule routers are equipped with an SNMP daemon, supporting basic MIB tables (such as ifTable), plus additional enterprise MIBs to manage multiple systems.

| Parameter | Supported MIBs |
|--------------------------|--|
| .1.3.6.1.2.1 | MIB-II (RFC1213), SNMPv2-MIB (RFC3418) |
| .1.3.6.1.2.1.2.1 | IF-MIB (RFC2863) |
| .1.3.6.1.2.1.4 | IP-MIB (RFC1213) |
| .1.3.6.1.2.1.10.131 | TUNNEL-MIB (RFC4087) |
| .1.3.6.1.2.25 | HOST-RESOURCES-MIB (RFC2790) |
| .1.3.6.1.6.3.10 | SNMP-FRAMEWORK-MIB |
| .1.3.6.1.6.3.11 | SNMPv2-SMI (RFC2578) |
| .1.0.8802.1.1.2 | LLDP-MIB |
| .1.0.8802.1.1.2.1.5.4795 | LLDP-EXT-MED-MIB |
| .1.3.6.1.4.1.31496 | VENDOR-MIB |

The VENDOR-MIB tables offer some additional information over the system and its WWAN, GNSS and WLAN interfaces. They can be accessed over the following OIDs:

| Parameter | Vendor MIB OID Assignment |
|--------------|---------------------------|
| NBAdminTable | .1.3.6.1.4.1.31496.10.40 |
| NBWwanTable | .1.3.6.1.4.1.31496.10.50 |
| NBGnssTable | .1.3.6.1.4.1.31496.10.51 |
| NBDioTable | .1.3.6.1.4.1.31496.10.53 |
| NBWlanTable | .1.3.6.1.4.1.31496.10.60 |
| NBWanTable | .1.3.6.1.4.1.31496.10.22 |

They offer facilities for:

- rebooting the device
- updating to a new system software via FTP/TFTP/HTTP
- updating to a new system configuration via FTP/TFTP/HTTP
- getting WWAN/GNSS/WLAN/DIO information

Our VENDOR-MIB is listed in the appendix or can be downloaded directly from the router.

SNMP Configuration

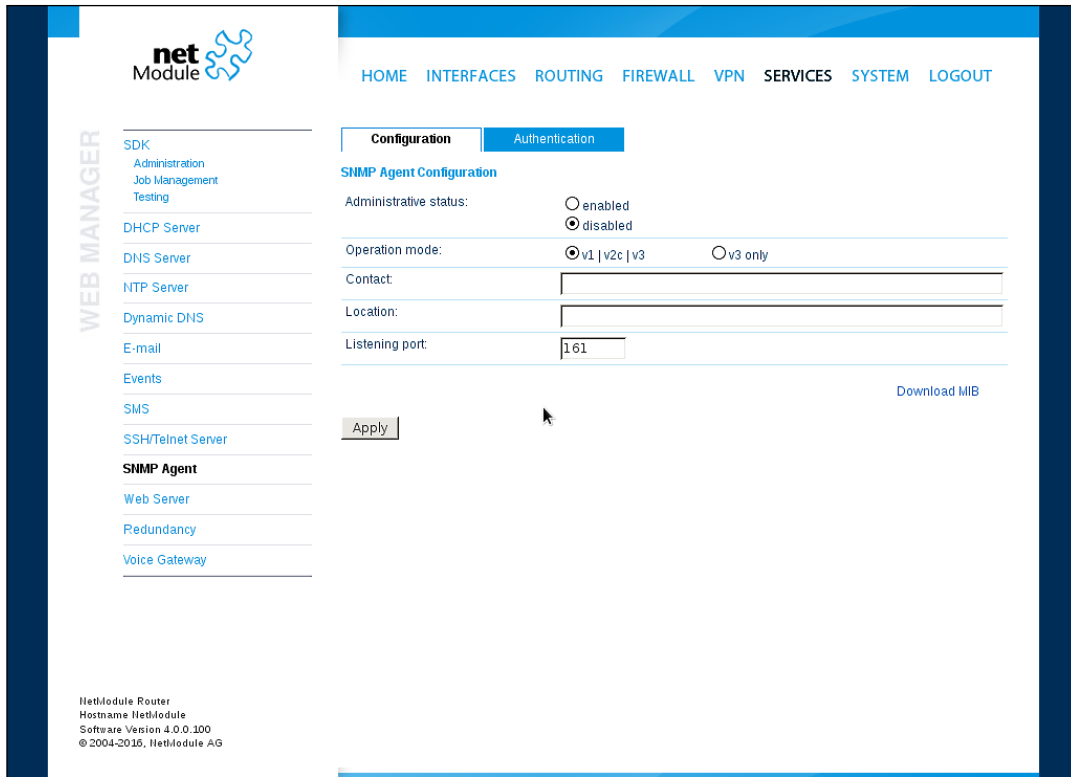

Figure 5.46.: SNMP Agent

The following parameters can be used to configure the SNMP agent:

| Parameter | SNMP Configuration |
|-----------------------|--|
| Administrative status | Enable or disable the SNMP agent |
| Operation mode | Specifies if agent should run in compatibility mode or for SNMPv3 only |
| Contact | System maintainer or other contact information |
| Location | Location of the device |
| Listening Port | SNMP agent port |

Once the SNMP agent is enabled, SNMP traps can be generated using SDK scripts.

SNMP Authentication

When running in SNMPv3, it is possible to configure the following authentication settings:

| Parameter | SNMPv3 Authentication |
|----------------|---|
| Authentication | Defines the authentication (MD5 or SHA) |
| Encryption | Defines the privacy protocols to use (DES or AES) |

In general, the admin user can read and write any values. Read access will be granted to any other system users.

There is no authentication/encryption in SNMPv1/v2c and should not be used to set any values. However, it is possible to define its communities and authoritative host which will be granted administrative access.

| Parameter | SNMPv1/v2c Authentication |
|-----------------|--|
| Read community | Defines the community name for read access |
| Admin community | Defines the community name for admin access |
| Allowed host | Defines the host which is allowed for admin access |

Attention must be paid to the fact that SNMP passwords have to be more than 8 characters long. Shorter passwords will be doubled for SNMP (e.g. admin01 becomes admin01admin01). Please note that the SNMP daemon is also listening on WAN interfaces and it is therefore suggested to restrict the access with the firewall.

Typical SNMP Commands

Setting MIB values and triggering extensions is generally limited to the SNMPv3 admin user. It is possible to specify an administrative host for SNMP v1/2c.

The SNMP extensions can be read and triggered as follows:

Getting the software version of the system:

```
snmpget -v 3 -u admin -n "" -l authNoPriv -a MD5 -x DES -A admin01admin01
192.168.1.1 1.3.6.1.4.1.31496.10.40.1.0
```

Getting the kernel version:

```
snmpget -v 3 -u admin -n "" -l authNoPriv -a MD5 -x DES -A admin01admin01
192.168.1.1 1.3.6.1.4.1.31496.10.40.2.0
```

Getting the serial number:

```
snmpget -v 3 -u admin -n "" -l authNoPriv -a MD5 -x DES -A admin01admin01
192.168.1.1 1.3.6.1.4.1.31496.10.40.3.0
```

Getting the current config description:

```
snmpget -v 3 -u admin -n "" -l authNoPriv -a MD5 -x DES -A admin01admin01
192.168.1.1 1.3.6.1.4.1.31496.10.40.4.0
```

Getting the current config hash:

```
snmpget -v 3 -u admin -n "" -l authNoPriv -a MD5 -x DES -A admin01admin01
192.168.1.1 1.3.6.1.4.1.31496.10.40.5.0
```

Restarting the device:

```
snmpset -v 3 -u admin -n "" -l authNoPriv -a MD5 -x DES -A admin01admin01
192.168.1.1 1.3.6.1.4.1.31496.10.40.10.0 i 1
```

Running a configuration update:

```
snmpset -v 3 -u admin -n "" -l authNoPriv -a MD5 -x DES -A admin01admin01
192.168.1.1 1.3.6.1.4.1.31496.10.40.11.0 s "http://server/directory"
```

You can use TFTP, HTTP, HTTPS and FTP URLs (specifying a username/password or a port is not yet supported).

Please note that config updates expect a zip-file named <serial-number>.zip in the specified directory.

Getting the configuration update status:

```
snmpget -v 3 -u admin -n "" -l authNoPriv -a MD5 -x DES -A admin01admin01
192.168.1.1 1.3.6.1.4.1.31496.10.40.12.0
```

The return value can be one of: succeeded (1), failed (2), inprogress (3), notstarted (4).

Running a software update:

```
snmpset -v 3 -u admin -n "" -l authNoPriv -a MD5 -x DES -A admin01admin01
192.168.1.1 1.3.6.1.4.1.31496.10.40.13.0 s "http://server/directory"
```

Getting the software update status:

```
snmpget -v 3 -u admin -n "" -l authNoPriv -a MD5 -x DES -A admin01admin01
192.168.1.1 1.3.6.1.4.1.31496.10.40.14.0
```

The return value can be one of: succeeded (1), failed (2), inprogress (3), notstarted (4).

Setting the update operation:

```
snmpset -v 3 -u admin -n "" -l authNoPriv -a MD5 -x DES -A admin01admin01
192.168.1.1 1.3.6.1.4.1.31496.10.40.15.0 i 1
```

By default, the update operation is set to update (0) which results in an immediate update of software or configuration once triggered. One may also set the operation to store (1) which will only store the software or configuration package. It can be later activated using the following switch operators.

Switching to alternative software:

```
snmpset -v 3 -u admin -n "" -l authNoPriv -a MD5 -x DES -A admin01admin01
192.168.1.1 1.3.6.1.4.1.31496.10.40.16.0 i 0
```

The return value can be derived from the software update status.

Switching to alternative config:

```
snmpset -v 3 -u admin -n "" -l authNoPriv -a MD5 -x DES -A admin01admin01
192.168.1.1 1.3.6.1.4.1.31496.10.40.16.0 i 1
```

The return value can be derived from the config update status.

Getting the alternative config description:

```
snmpget -v 3 -u admin -n "" -l authNoPriv -a MD5 -x DES -A admin01admin01
192.168.1.1 1.3.6.1.4.1.31496.10.40.17.0
```

Getting the alternative config hash:

```
snmpget -v 3 -u admin -n "" -l authNoPriv -a MD5 -x DES -A admin01admin01
192.168.1.1 1.3.6.1.4.1.31496.10.40.18.0
```

Getting the alternative software version:

```
snmpget -v 3 -u admin -n "" -l authNoPriv -a MD5 -x DES -A admin01admin01
192.168.1.1 1.3.6.1.4.1.31496.10.40.19.0
```

Getting the alternative software hash:

```
snmpget -v 3 -u admin -n "" -l authNoPriv -a MD5 -x DES -A admin01admin01
192.168.1.1 1.3.6.1.4.1.31496.10.40.20.0
```

Setting digital OUT1:

```
snmpset -v 3 -u admin -n "" -l authNoPriv -a MD5 -x DES -A admin01admin01
192.168.1.1 .1.3.6.1.4.1.31496.10.53.10.0 i 0
snmpset -v 3 -u admin -n "" -l authNoPriv -a MD5 -x DES -A admin01admin01
192.168.1.1 .1.3.6.1.4.1.31496.10.53.10.0 i 1
```

Setting digital OUT2:

```
snmpset -v 3 -u admin -n "" -l authNoPriv -a MD5 -x DES -A admin01admin01
192.168.1.1 .1.3.6.1.4.1.31496.10.53.11.0 i 0
snmpset -v 3 -u admin -n "" -l authNoPriv -a MD5 -x DES -A admin01admin01
192.168.1.1 .1.3.6.1.4.1.31496.10.53.11.0 i 1
```

Listing discovered devices:

```
snmpget -v 3 -u admin -n "" -l authNoPriv -a MD5 -x DES -A admin01admin01
192.168.1.1 .1.0.8802.1.1
```

5.7.11. Web Server

This page can be used to configure different ports for accessing the Web Manager via HTTP/HTTPS. We strongly recommend to use HTTPS when accessing the web service via a WAN interface as the communication will be encrypted and thus avoids any misuse of the system.

In order to enable HTTPS you would need to generate or upload a server certificate in the section 5.8.8.

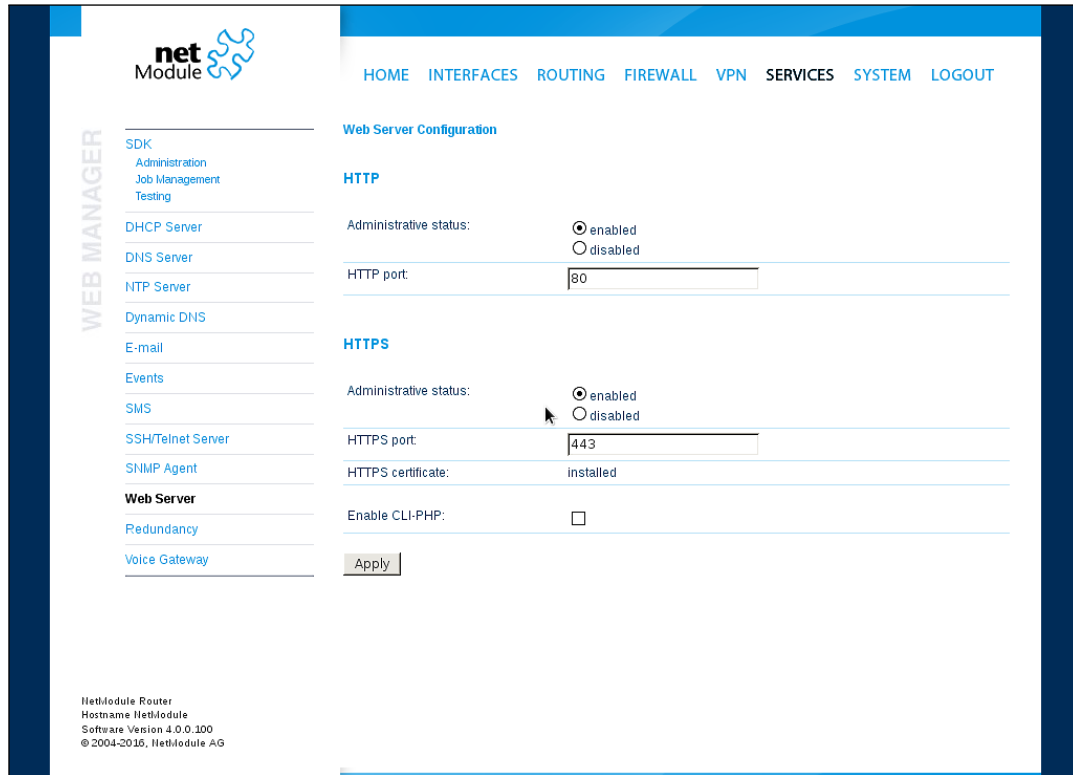

Figure 5.47.: Web Server

| Parameter | Web Server Settings |
|-----------------------|---|
| Administrative Status | Enable or disable the Web server |
| HTTP port | Web server port for HTTP connections |
| HTTPS port | Web server port for HTTPS connections |
| Enable CLI-PHP | Enable CLI-PHP service (see chapter 6.17) |

5.7.12. Discovery

This page can be used to enabled discovery protocols which can be used to discover and to get discovered by other hosts.

| Parameter | Discovery Configuration |
|-----------------------|-------------------------------------|
| Administrative status | Administrative status |
| Enabled protocols | List of enabled discovery protocols |

The following protocols are supported:

| Parameter | Discovery Configuration |
|-----------|--------------------------------|
| LLDP | Link Layer Discovery Protocol |
| CDP | Cisco Discovery Protocol |
| FDP | Foundry Discovery Protocol |
| SONMP | Nortel Discovery Protocol |
| EDP | Extreme Discovery Protocol |
| IRDP | ICMP Router Discovery Protocol |

IRDP implements RFC1256 and can also inform locally connected hosts about the nexthop gateway. Any discovered hosts will be exposed to the LLDP-MIB and can be queried over SNMP or CLI/GUI.

5.7.13. Redundancy

This page can be used to set up a redundant pair of NetModule routers (or other systems) by running the Virtual Router Redundancy Protocol (VRRP) between them. A typical VRRP scenario defines a first host playing the master and another the backup device, they both define a virtual gateway IP address which will be distributed by gratuitous ARP messages for updating the ARP cache of all LAN hosts and thus redirecting the packets accordingly. A takeover will happen within approximately 3 seconds as soon as the partner is not reachable anymore (checked via multicast packets). This may happen when one device is rebooting or the Ethernet link went down. Same applies when the WAN link goes down.

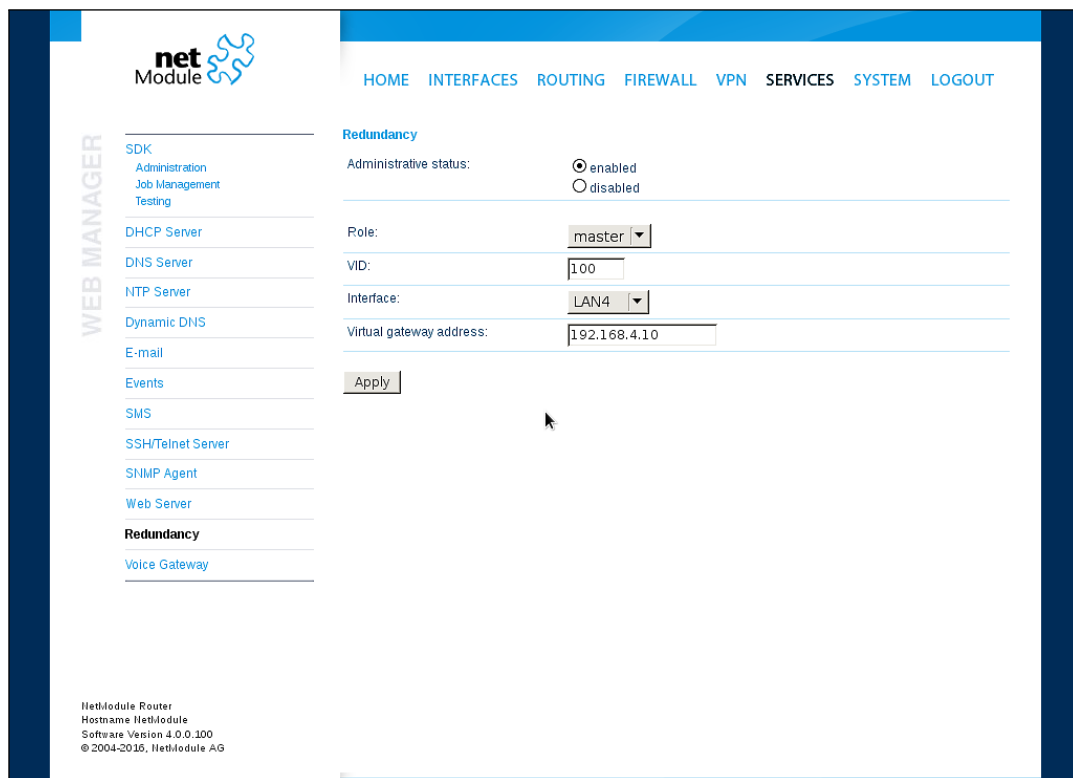

Figure 5.48.: VRRP Configuration

In case DHCP has been activated, please keep in mind that you will need to reconfigure the DHCP gateway address offered by the server and let them point to the virtual gateway address. In order to avoid conflicts you may turn off DHCP on the backup device or even better, split the DHCP lease range across both routers in order to prevent any lease duplication.

| Parameter | Redundancy Configuration |
|-----------------------|--|
| Administrative status | Administrative status |
| Role | The role of this system (either master or backup) |
| VID | The Virtual Router ID (you can theoretically run multiple instances) |

| Parameter | Redundancy Configuration |
|-------------------------|---|
| Interface | Interface on which VRRP should be performed |
| Virtual gateway address | The virtual gateway address formed by the participating hosts |

We assign a priority of 100 to the master and 1 to the backup router. Please adapt the priority of your third-party device appropriately.

5.7.14. Voice Gateway

Depending on your hardware, you can set up a voice gateway on the router which can be used to connect mobile calls to VoIP clients and vice versa.

Administration

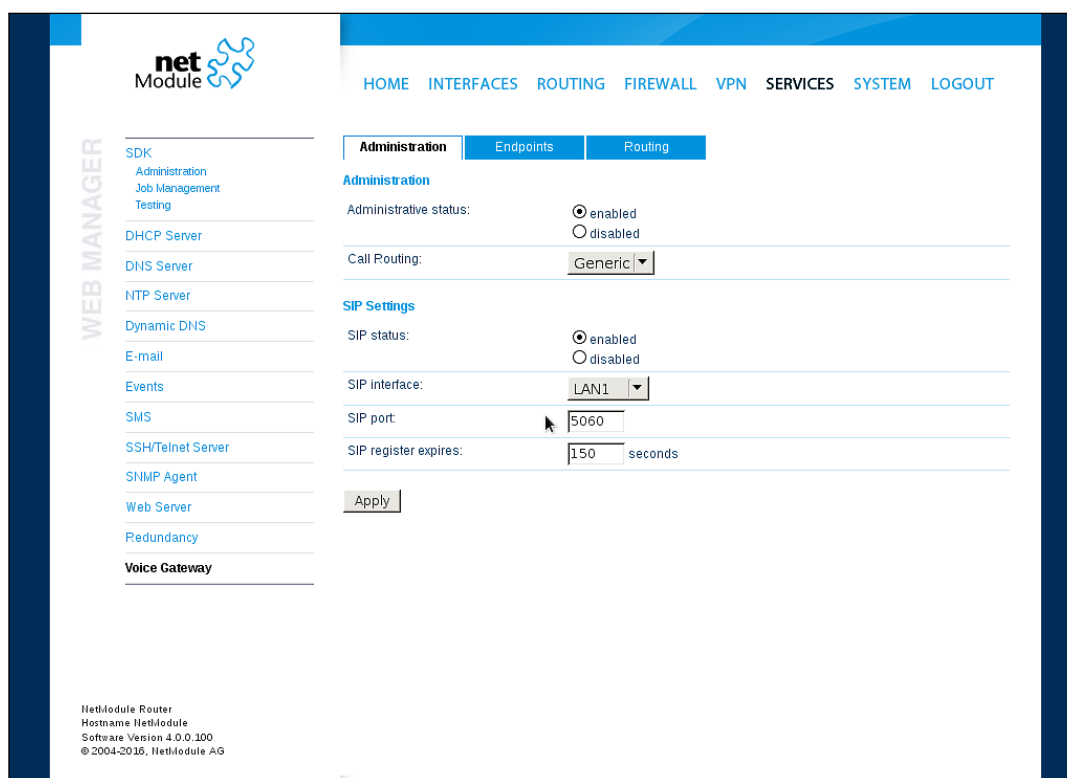

Figure 5.49.: Voice Gateway Administration

The following parameters can be used to set it up:

| Parameter | Voice Gateway Administration Settings |
|-----------------------|---|
| Administrative status | Specifies whether the gateway shall be enabled or disabled |
| Call routing | Defines who will be responsible for call routing. If SDK has been specified you would need to install a script (see examples) which will be responsible for routing and accepting the calls. Otherwise the static routing configuration will be used. |
| SIP status | Specifies whether the SIP agent will be enabled or disabled |
| SIP interface | Specifies the interface (LAN or WAN) on which the agent should listen for incoming calls |
| SIP port | Specifies the agent's listening port |

| Parameter | Voice Gateway Administration Settings |
|----------------------|--|
| SIP user name | Specifies the username used in from headers |
| SIP register expires | Specifies the registration interval in seconds |

In case you are running multiple WWAN interfaces sharing the same SIM, please bear in mind that the system may switch SIMs during operation which will also result in different settings for voice communication.

Voice Endpoints

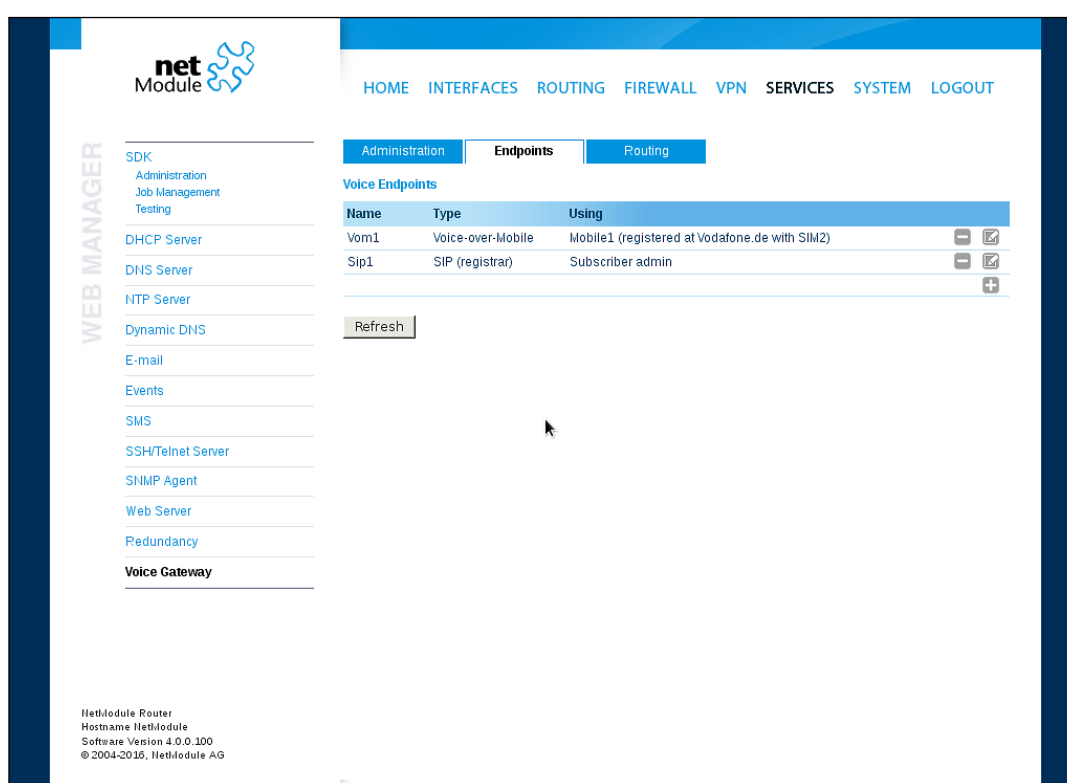

Figure 5.50.: Voice Gateway Endpoint Configuration

On this page you can activate the endpoints used for voice communication, the following types are supported:

| Parameter | Voice Gateway Endpoint Types |
|-------------------|--|
| Voice-Over-Mobile | Endpoint for GSM/UMTS/LTE calls (can be used for calls to mobile or landline phones) |
| SIP (registrar) | SIP endpoint which can be a client registered to our registrar |
| SIP (direct) | Endpoint for calls directly routed to a SIP agent without registration |

| Parameter | Voice Gateway Endpoint Types |
|------------------|--|
| SIP (user-agent) | Endpoint acting as SIP user agent towards a remote registrar |

Based on your equipment, we recommend to adjust the modem's audio profile for a better sound experience. The following profiles are available:

| Parameter | Voice-Over-Mobile Audio Profiles |
|--------------|--|
| Handset | Provides a mild echo, short delay (less than 16-ms dispersion). This mode is intended for use with a well-designed handset, where the Echo Return Loss (ERL) is generally high. Full-duplex performance is easiest to achieve in this mode. |
| Headset | Provides a moderate echo, short delay (less than 16-ms dispersion). This mode is intended for use in situations where the echo may be loud but low in delay. There are a variety of different headsets available with a wide variety of echo characteristics and noise pickup. Although the echo delay is typically short (< 16 ms) with all headsets, the echo return loss characteristics can vary significantly and are not well known a priori to the handset designer. This mode is more robust and more aggressive at echo cancellation. |
| Speakerphone | Handle situations of loud echo with extreme acoustic distortion. This mode is intended for use with a car kit or speakerphone applications with high volume and high distortion. Acoustic echo in this situation has negative ERL and is impossible to cancel completely. It operates in a half-duplex manner and will be very aggressive in muting the entire signal to prevent any echo blips from being heard. |
| Bluetooth | Provides moderate echo, long delay (up to 64-ms dispersion). This mode is intended for bluetooth headsets and carkits which may have DSP processing on board and could give added delay to the system. |

| Parameter | Endpoint Settings Voice-Over-Mobile |
|---------------|--|
| Modem | Specifies the modem which will be used for voice-over-mobile calls |
| Audio profile | Specifies the modem's audio profile |
| Volume level | Specifies the modem's volume level - 1 = low |

| Parameter | Endpoint Settings SIP (registrar) |
|------------|--|
| Subscriber | The subscriber name for a registering SIP client |
| Username | The username for a registering SIP client |
| Password | The password for a registering SIP client |

| Parameter | Endpoint Settings SIP (direct) |
|------------|---|
| Subscriber | The subscriber name of the SIP agent |
| Host | The IP address of the SIP agent |
| Port | The port of the SIP agent |
| Username | The username to authenticate at the SIP agent |
| Password | The password used for authentication |

| Parameter | Endpoint Settings SIP (user-agent) |
|------------|---|
| Host | The IP address of the remote SIP registrar |
| Port | The port of the registrar |
| Domain | The domain name used at the registrar |
| Subscriber | The subscriber name used at the registrar |
| Username | The username to authenticate at the registrar |
| Password | The password used for authentication |
| Register | Selects whether the user-agent shall register at the registrar |
| Expires | The expiry time in seconds after registration will be triggered again |

Voice Routing

This page can be used to configure generic voice routing between the endpoints.

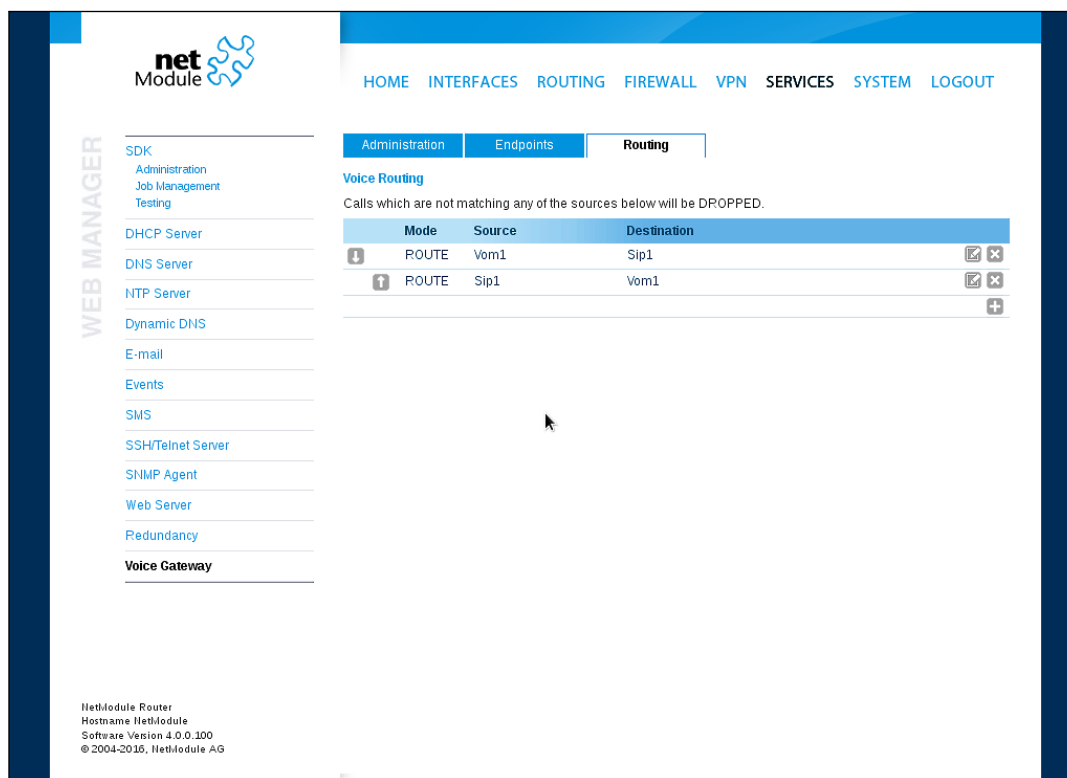

Figure 5.51.: Voice Gateway Routing Configuration

Enhanced routing facilities are provided via the SDK interface which is able to dispatch voice calls based on their attributes (such as phone number) and other system related status information (e.g. number/duration of calls per endpoint, registration status and so on). Using the SDK, you can also initiate or accept a call, adjust its volume level or do a hangup. Anyway, for simple scenarios the generic method should be sufficient and can be configured as follows:

| Parameter | Voice Gateway Routing Settings |
|-------------|--|
| Source | Specifies the source endpoint (i.e. where the call comes in) |
| Mode | The type of action which shall be applied for the call: DROP will silently hangup the call, ROUTE will route the call to the specified endpoint. |
| Destination | Specifies the target endpoint (i.e. where to call is routed to) |

Client Configuration

Any SIP client must be configured to use the router as its registrar/proxy.

| Parameter | X-Lite Configuration |
|--------------------|--|
| User ID | SIP username used in from headers (i.e. subscriber name) |
| Domain | SIP Domain used in from headers (optional) |
| Authorization name | Username used for authentication (i.e. subscriber name) |
| Password | Password used for authentication |
| Display name | Name to be displayed on the handset |

5.8. SYSTEM

5.8.1. System

System Settings

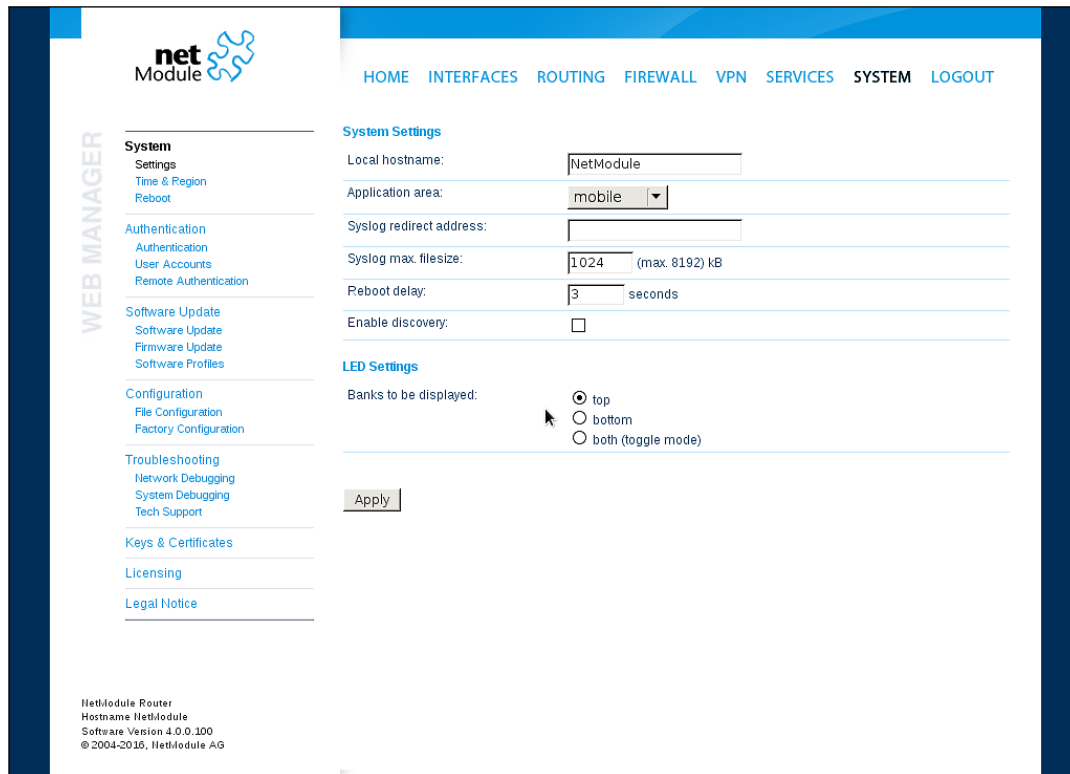

Figure 5.52.: System

System

The following system parameters can be set:

| Parameter | System Settings |
|------------------|--|
| Local hostname | The hostname of the system |
| Application area | The desired application area which influences the system behaviour such as registration timeouts or other adaptations when operating in mobile environments. |
| Reboot delay | The number of seconds which will be waited before regular system reboots (might be needed for system-rebooting events) |

| Parameter | System Settings |
|-----------------------|--|
| Enable TCP timestamps | Enable TCP timestamps for system wide TCP communication. This is needed for Protection Against Wrapped Sequence numbers (PAWS), but with these timestamps enabled a remote attacker can guess the uptime of the system. The uptime is a lower bound for the age of the main system components like the kernel. If the system has an uptime of 3 years it's unlikely that recent security patches were applied. |

Syslog

The following syslog parameters can be set:

| Parameter | Syslog Settings |
|------------------|---|
| Storage | The storage device on which log files shall be stored. |
| Max. filesize | The maximum size of the log files (in kB) until they will get rotated. |
| Redirect address | Specifies an IP address to which log messages should be redirected to. A tiny system log server for Windows is included in TFTP32 which can be downloaded from our website. |

In general, the box comes with an internal flash device which can be used to store data. Depending on your model this can be extended by additional flash or USB disks. The following storage devices exist:

| Parameter | Storage Devices |
|---------------|---|
| flash root | The root partition of the internal flash |
| flash data | The data partition of the internal flash |
| extended disk | An extended storage disk |
| USB disk | A storage disk connected to the external USB port |

LEDs

The following LED parameters can be set:

| Parameter | LED Settings |
|-----------------------|---|
| Banks to be displayed | You can configure the behavior of the status LEDs on the front panel of your device. They are usually divided into two banks (top/bottom) and are either indicating the connection status or the digital IO port status. You may configure toggle mode, so that the LEDs periodically cycle between the two states. |

Bootloader

The following bootloader parameters can be set:

| Parameter | Bootloader Settings |
|-----------|--|
| Password | The password used to unlock the bootloader. If empty, the admin password will be used. |

Time & Region

This page can be used for setting the system time and configuring the time zone. You may further enable daylight saving changes for your specific time zone. NetModule routers can synchronize their system time by using one or more servers by the help of the Network Time Protocol (NTP) or via GNSS. If enabled, the time synchronization is usually triggered after a WAN link has come up but before starting any VPN connections. Further time synchronization cycles are scheduled in background.

Most routers don't have a battery backed clock (RTC). In this case the system time is set during boot to the last valide time, e.g. before power off.

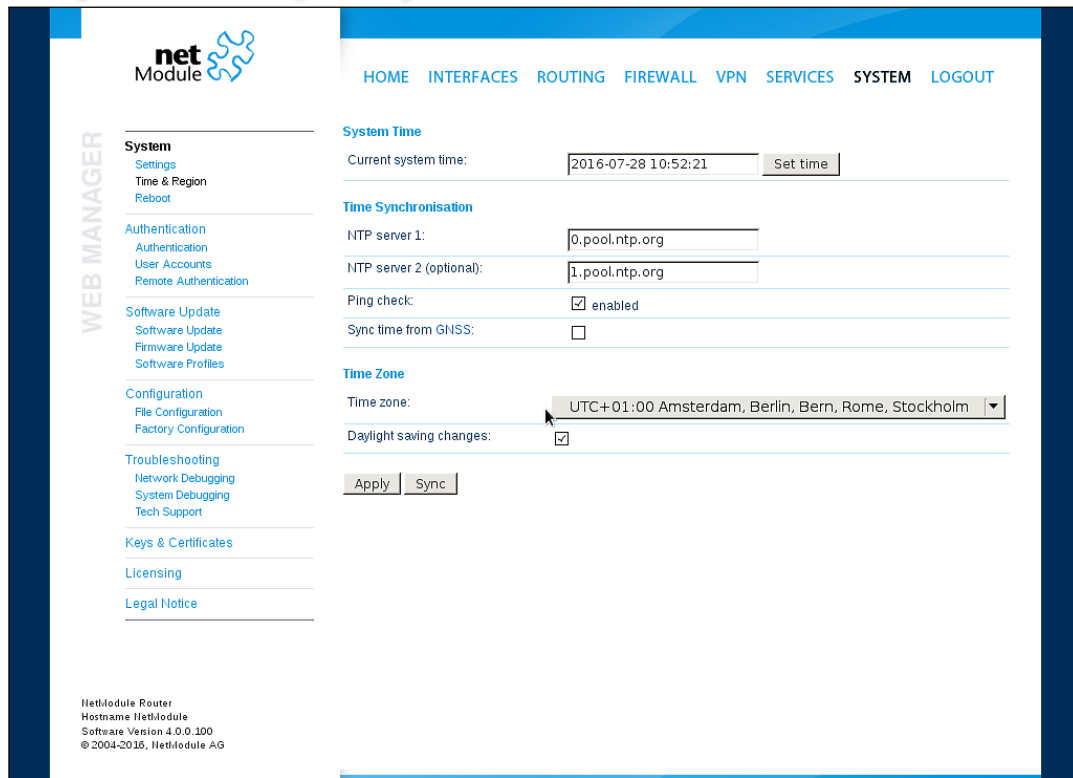

Figure 5.53.: Regional settings

| Parameter | Time Synchronisation |
|---------------------|---|
| NTP server | Address of the primary NTP server |
| NTP server 2 | Optionally, the address of a second NTP server |
| Ping check | Uses an ICMP ping to check whether NTP servers are available when running initial time update |
| Sync time from GNSS | Derive time from first GNSS device (if enabled) |

| Parameter | Time Zone |
|-------------------------|---|
| Time Zone | Set the local time zone. |
| Daylight saving changes | Enable/disable daylight saving changes. |

Reboot

This page can be used to set up a periodic automatic reboot but also to trigger a manual reboot which will be issued immediately.

5.8.2. Authentication

This page can be used to define the access model for all management interfaces (e.g. GUI, SSH/telnet server).

| Parameter | Authentication Methods |
|---------------------------------|---|
| Authentication required | Users can login via HTTP/telnet if authentication succeeds |
| Secure authentication required | Users can only login via HTTPS/ssh |
| Secure authentication preferred | Users will be redirected to HTTPS but can still login via HTTP/telnet |

User Accounts

By using this page you can manage the user accounts on the system.

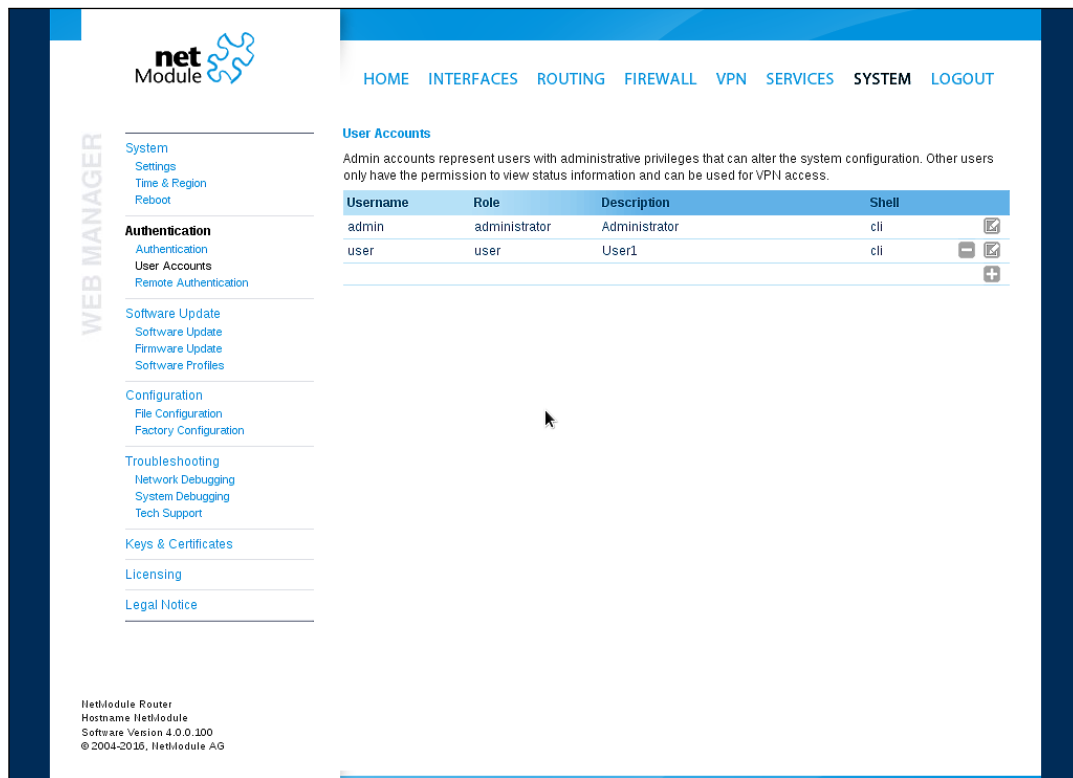

Figure 5.54.: User Accounts

The `admin` user is a built-in power user which represents the default administrator of the system. Please note that the `admin` password will be also applied to the `root` user which is able to enter a system shell. Further admin accounts with administrative privileges can be added, they can also alter the system configuration or perform administrative system tasks. Other users only have the permission to view status information. They can be also used for VPN access.

The Web Manager supports up to 5 concurrent users. Inactive users will be kicked after being idle for 30 minutes. If login was successful, any duplicate users from other remote hosts will be logged out. Remote hosts will be blocked for 5 minutes after 10 failed login attempts.

| Parameter | User accounts management |
|----------------------|--|
| Username | The name of the user |
| Role | Either admin or user |
| Old password | The old password of the user |
| New password | The new password of the user |
| Confirm new password | The confirmed new password of the user |

Please note, when adding additional admin users you are required to provide the password of the default administrator.

Remote Authentication

A RADIUS server can be used for authenticating remote users. This applies for the Web Manager, the WLAN network and other services supporting and incorporating remote authentication.

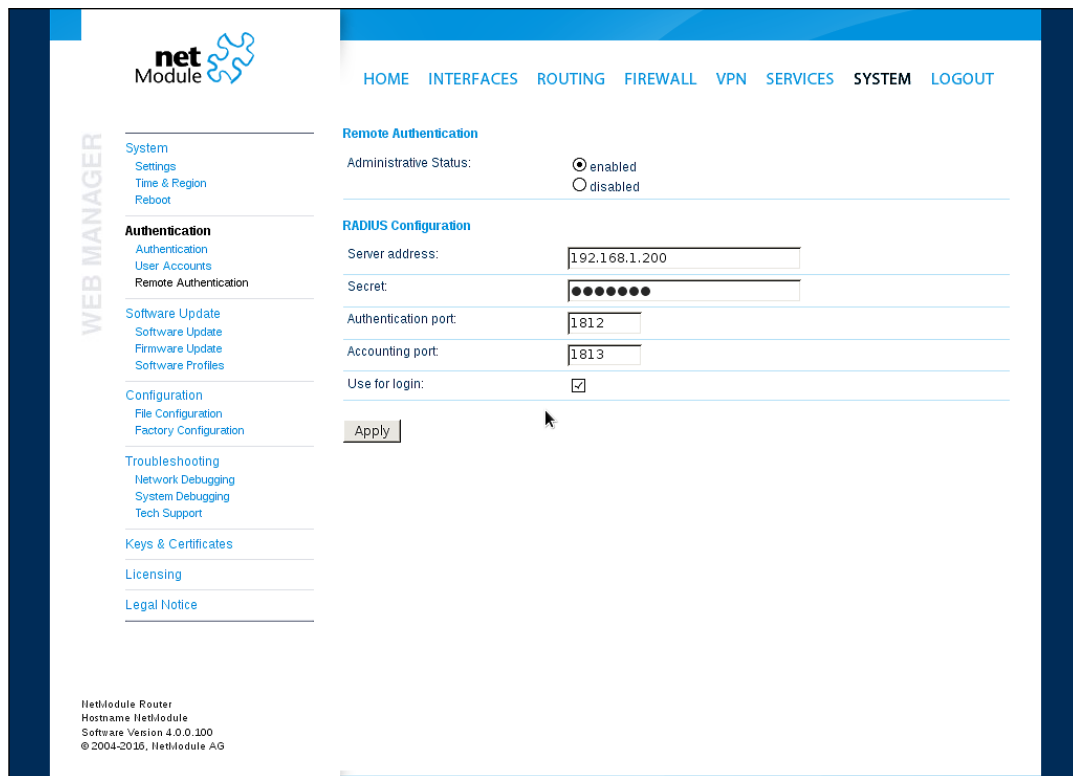

Figure 5.55.: Remote Authentication

It can be configured as follows:

| Parameter | Remote authentication settings |
|-----------------------|---|
| Administrative status | Defines whether a remote server should be used for authentication |
| RADIUS server | The RADIUS server address |
| RADIUS secret | The secret used to authenticate against the RADIUS server |
| Authentication port | The port used for authentication |
| Accounting port | The port used for accounting messages |
| Use for login | This option enables remotely-defined users to access the Web Manager, otherwise it is only used by services which have explicitly configured it (e.g. WLAN) |

5.8.3. Software Update

Manual Software Update

This menu can be used to run a manual software update of the system.

| Parameter | Manual Software Update |
|------------------|---|
| Update operation | The update operation method being used. You can upload the image, download it from an URL or use the latest version from our server |
| URL | The server URL where the software update image should be downloaded from |

An Uniform Resource Locator (URL) can have the following format:

```
http://<username>:<password>@<host>:<port>/<path>
https://<username>:<password>@<host>:<port>/<path>
ftp://<username>:<password>@<host>:<port>/<path>
sftp://<username>:<password>@<host>:<port>/<path>
tftp://<host>/<path>
file:///<path>
```

When issuing a software update, the current configuration (including files like keys/certificates) will be backed up. Any other modifications to the filesystem will be erased.

The configuration is generally backward-compatible. We also apply forward compatibility when downgrading to a previous software within the same release line, which is accomplished by sorting out unknown configuration directives which actually may lead to loss of settings and features. Therefore, it's always a good idea to keep a copy of the working configuration.



Attention

In case you perform a major downgrade with a previous release line (e.g. 3.7.0 to 3.6.0), please ensure to always use the latest release of that branch (i.e. 3.6.0.X) as only those tend to be fully forward-compatible. Also keep in mind, that some hardware features may not work (e.g. if not implemented in that version). In doubt, please consult our support team.

A software image can be either uploaded via the Web Manager or retrieved from a specific URL. It will be unpacked and deployed to a spare partition which gets activated if the update completed successfully. The whole procedure is accompanied by all green LEDs flashing up, the subsequent system reboot gets denoted by a slowly blinking Status LED. The backed-up configuration will be applied at bootup and the Status LED will blink faster during this operation. Depending on your configuration, this may take a while.

Automatic Software Update

This menu can be used to run a automatic software update of the system.

| Parameter | Automatic software update |
|-------------|---|
| Status | Enable/disable automatic software update |
| Time of day | Every day at this time the router will do a check for updates |
| Operation | Download latest image from the the server or specify the URL where the software update package should be downloaded from. Supported protocols are TFTP, HTTP, HTTPS, and FTP. Provide a URL like <code>protocol://server/path/file</code> |

Remark: SSL certificates of HTTPS URLs will be only verified if a list of CA root certificates are provided under [5.8.8](#).

After the new software has been installed, the latest running configuration will be applied afterwards during bootup. This is indicated by a faster green blinking of the Status LED.

5.8.4. Module Firmware Update

This menu can be used to perform a firmware update of a specific module.

| Parameter | Module Firmware Update |
|------------------|--|
| Update operation | The update operation method being used. You can either upload a firmware package or download it from a specific URL. |
| Module | The module which shall be updated. |
| Storage | The temporary storage which shall be used for the update procedure. For boxes with limited amount of flash it is possible to use an USB stick which must be properly set up in the USB section and hold a proper filesystem such as ext4. |
| URL | The server URL where the firmware package should be downloaded from (e.g. <code>protocol://server/path/file</code>). Supported protocols are TFTP, HTTP, HTTPS, and FTP. For boxes with limited amount of flash you may also use <code>usb0://<path-to-firmware-package></code> . |

A firmware package (ZIP) usually consists of a flash utility, an info file and the corresponding firmware files. Please follow <http://www.netmodule.com/support/supportform.aspx> in order to get the latest version.

5.8.5. Software Profiles

The system consists of two root partitions which can hold different software versions and this menu can be used to switch between them. By doing so, you can test a newer software version and simply switch-back if things go wrong.

5.8.6. Configuration

Configuration via the Web Manager becomes tedious for larger volumes of devices. The router therefore offers automatic and manual file-based configuration to automate things. Once you have successfully set up the system you can back up the configuration and restore the system with it afterwards. You can either upload a single configuration file (.cfg) or a complete package (.zip) containing the configuration file and a packed version of other essential files (such as certificates) in the root directory.

Manual File Configuration

The screenshot displays the NetModule Web Manager interface. The top navigation bar includes links for HOME, INTERFACES, ROUTING, FIREWALL, VPN, SERVICES, SYSTEM, and LOGOUT. The left sidebar, labeled 'WEB MANAGER', lists various system settings such as System, Authentication, Software Update, Configuration, Troubleshooting, Keys & Certificates, Licensing, and Legal Notice. The main content area is titled 'File Configuration' and features two tabs: 'File Configuration' (selected) and 'Automatic Updates'. Under 'Current Configuration', there is a table with the following data:

| | | |
|----------------|----------------------------------|-----|
| Description: | user-config | Set |
| Version: | 1.8 | |
| Last modified: | 2016-07-28 10:49:52 | |
| Hash: | 49a204a8caec4f331398afcb47c042f9 | |

Below the table, the 'File Configuration' section includes an 'Operation:' label and three radio button options:

- Download configuration file
- Upload configuration file
- Update configuration from URL

A 'Download' button is located below these options.

At the bottom left of the interface, the following information is displayed:

```
NetModule Router
Hostname NetModule
Software Version 4.0.0.100
© 2004-2016, NetModule AG
```

Figure 5.56.: Manual File Configuration

This section can be used to download the currently running system configuration (including essential files such as certificates). In order to restore a particular configuration you can upload a configuration previously downloaded. You can choose between missing configuration directives set to factory defaults or getting ignored, that means, potentially existing configuration directives will be kept at the system.

Automatic File Configuration

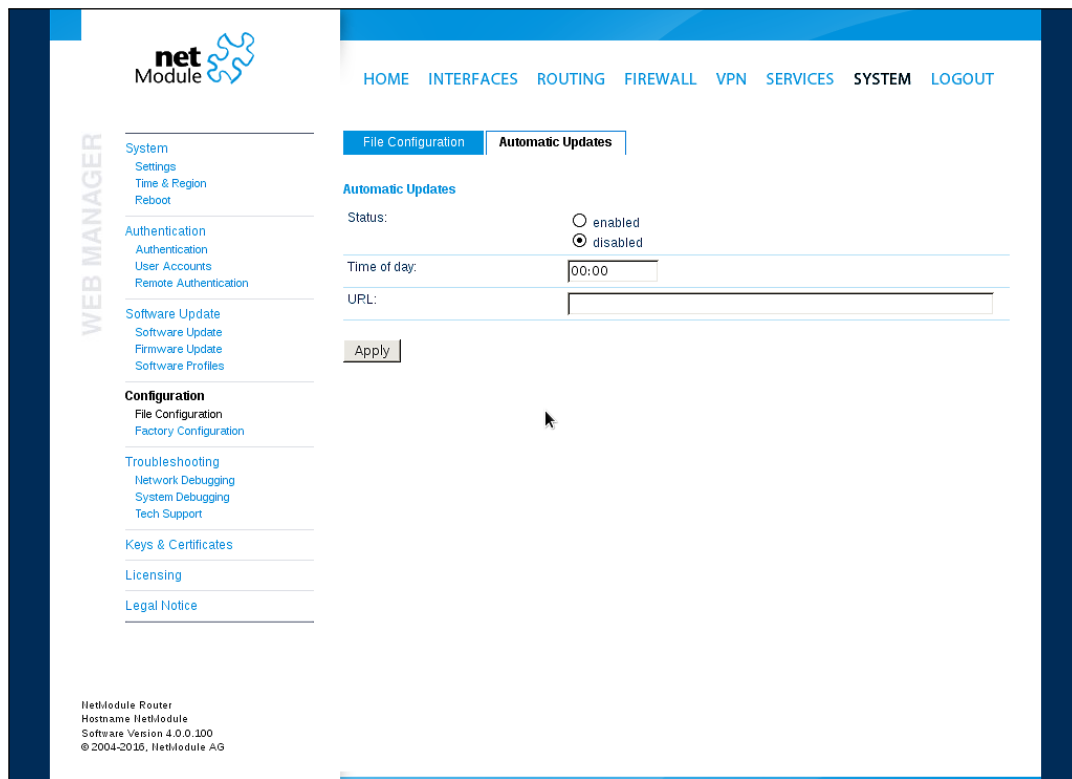

Figure 5.57.: Automatic File Configuration

This menu can be used to run an automatic configuration update of the system. It is configured as follows:

| Parameter | Automatic File Configuration |
|-------------|--|
| Status | Enable/disable an automatic configuration update |
| Time of day | Time of day when the system should check for updates |
| URL | The URL where the configuration file should be retrieved from (supported protocols are HTTP, HTTPS, TFTP, FTP) |

Factory Configuration

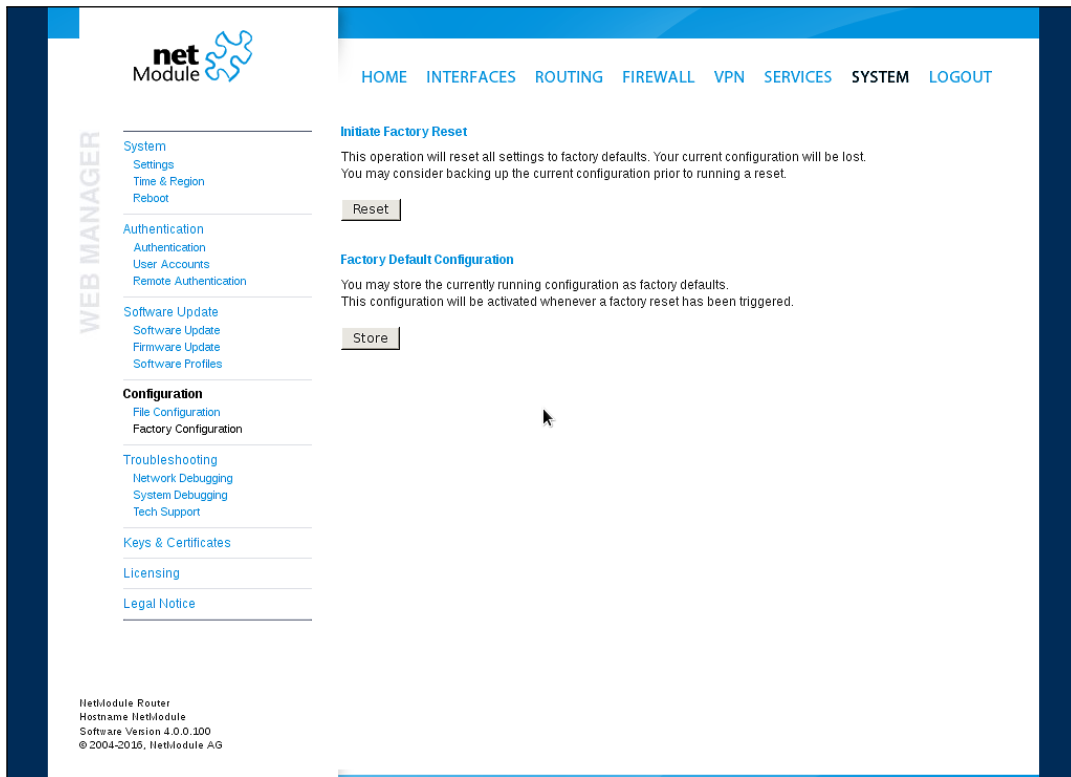

Figure 5.58.: Factory Configuration

This menu can be used to reset the device to factory defaults. Your current configuration will be lost. This procedure can also be initiated by pressing and holding the *Reset* button for at least five seconds. A successfully initiated factory reset can be noticed by all LEDs having been turned on. The factory reset will set the IP address of the first Ethernet interface back to 192.168.1.1. You will be able to communicate again with the device using the default network parameters. You may store the currently running configuration as factory defaults which will reside active even when a factory reset has been initiated (e.g. by your service staff).

Please ensure that this corresponds to a working configuration. A real factory reset to the default settings can be achieved by restoring the original factory configuration and initiating the factory reset again.

5.8.7. Troubleshooting

Network Debugging

There are several tools for network debugging like ping, traceroute, tcpdump and darkstat.

| Parameter | Automatic software update |
|-------------|---|
| Ping | The ping utility can be used to verify whether a remote host can be reached via IP. |
| Time of day | The traceroute utility can be used to print the route packets trace to a remote host. |
| Tcpdump | The tcpdump utility generates a network capture (PCAP) of an interface which can be later analyzed with Wireshark. |
| Darkstat | The darkstat utility can be used to visualize your current network connections and traffic on a particular interface. |

System Debugging

You can view the system log here by selection the option *Debug log* or if you are interested in the boot log select *Boot log*.

Another way to see what is going on on the box is opening a SSH or Telnet session as *root* and typing `tail -log`. Furthermore the system log can be redirected to a syslog server, see section 5.8.1.

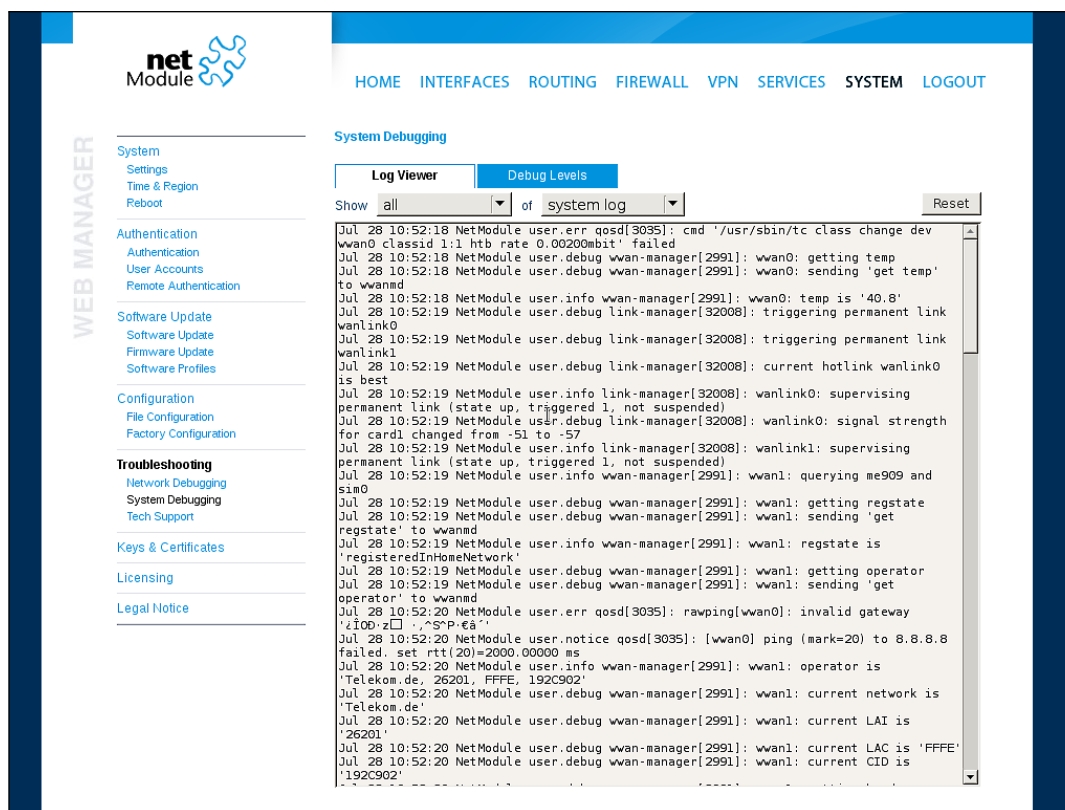

Figure 5.59.: Log Viewer

Tech Support

You can generate and download a tech support file here. We strongly recommend providing this file when getting in touch with our support team, either by e-mail or via our on-line support form, as it would significantly speed up the process of analyzing and resolving your problem. Log files can be viewed a downloaded and reset here. Please study them carefully in case of any issues. Various tools reside on this page for further analysis of potential configuration issues.

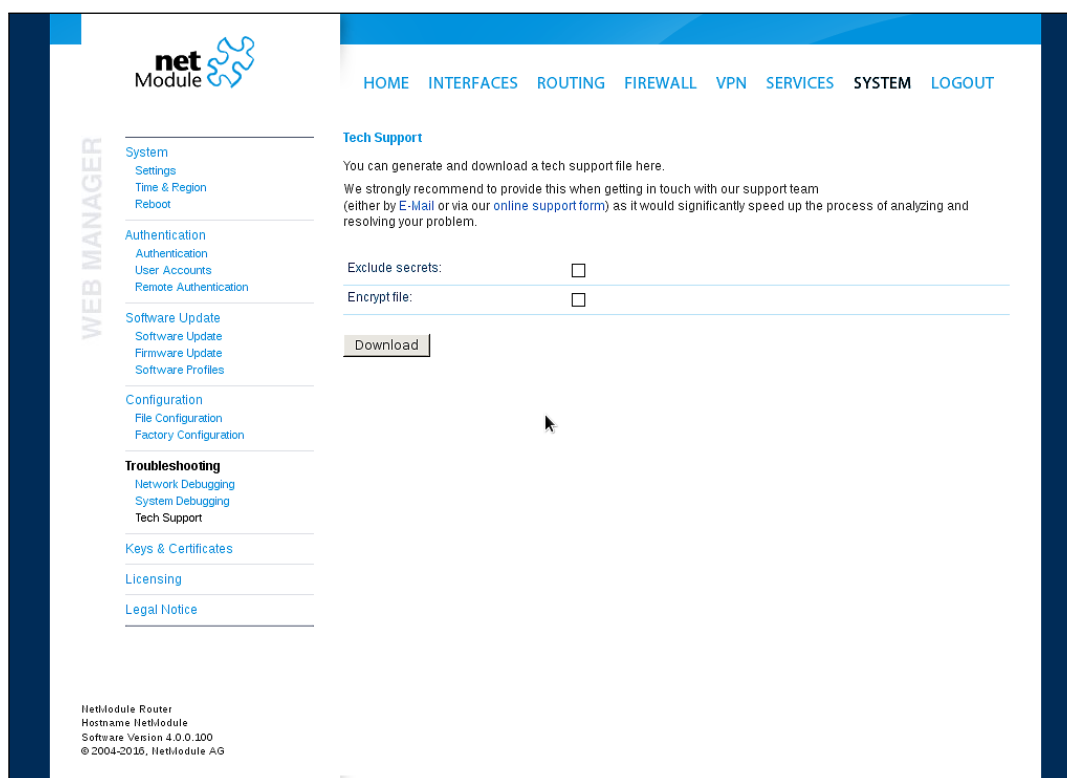

Figure 5.60.: Tech Support File

It is possible to trace any IP interface and inspect individual packet flows between hosts. This can be achieved by logging onto the box and start a network packet capture by using the tool *tcdump*. We recommend to use the *-n* switch to bypass name resolution (e.g. *tcpdump -n -i lan0*). You may also generate a dump in PCAP format using the Web Manager, download it to your computer and perform further inspections with Wireshark (available at www.wireshark.org).

5.8.8. Keys and Certificates

The key and certificate page lets you generate required files for securing your services (such as HTTP and SSH server) but also to implement authentication and encryption for certificate-based VPN tunnels and WLAN clients.

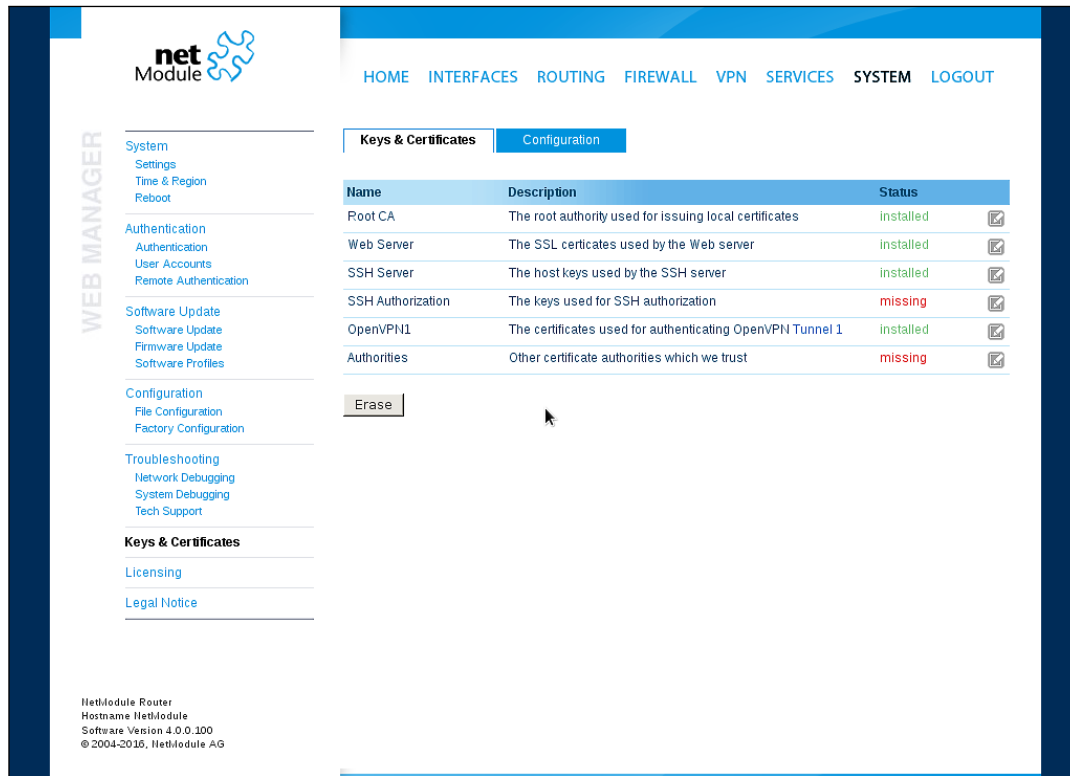

Figure 5.61.: Keys and certificates

The entry pages shows an overview about installed keys and certificates. The following sections may appear:

| Type | Description |
|-------------------|--|
| Root CA | The root Certificate Authority (CA) which issues certificates, its key can be used to certify it at trusted third party on other systems |
| Web Server | The certificates for the Web server required for running HTTP over SSL (HTTPS). |
| SSH Server | The DSS/DSA keys for the SSH server. |
| SSH Authorization | The keys used for SSH authorization. |
| OpenVPN | Server or client keys and certificates for running OpenVPN tunnels. |

| Type | Description |
|-------------|--|
| IPsec | Server or client keys and certificates for running IPsec tunnels. |
| WLAN | Keys and certificates for implementing certificate-based WLAN authentication (e.g. WPA-EAP-TLS). |
| Authorities | Other certificate authorities which we trust when establishing SSL client connections. |

Table 5.135.: Certificate Sections

For each certificate section it is possible to perform the following operations:

| Operation | Description |
|------------------------|--|
| generate locally | Generate key and certificate locally on the box (see 5.8.8 for more options) |
| upload files | Key and certificate will be uploaded. We support files in PKCS12, PKCS7, PEM/DER format as well as RSA/DSS keys in OpenSSH or Dropbear format. |
| enroll via SCEP | Enroll key and certificate via SCEP (see 5.8.8 for more options) |
| download certificate | Download key and certificate in ZIP format (files will be encoded in PEM format) |
| create signing request | Generate key locally and create a signing request to retrieve a certificate signed by another authority |
| erase certificate | Erase all keys and certificates associated with this section |

Table 5.136.: Certificate Operations

Configuration

The screenshot shows the 'Configuration' page for 'Keys & Certificates'. The left sidebar contains a 'WEB MANAGER' menu with categories like System, Authentication, Software Update, Configuration, Troubleshooting, Keys & Certificates, Licensing, and Legal Notice. The main content area has a top navigation bar with links: HOME, INTERFACES, ROUTING, FIREWALL, VPN, SERVICES, SYSTEM, LOGOUT. Below this, there are tabs for 'Keys & Certificates' and 'Configuration'. The configuration fields are as follows:

- Organization (O): NetModule
- Department (OU): Networking
- Location (L): Switzerland
- State (ST): Switzerland
- Country (C): Switzerland
- Common Name (CN):
- E-Mail: router@support.netmodule.com
- Expiry period: 7300 days
- Key size: 2048 bits
- DH primes: 1024 bits
- Signature: md5
- Passphrase: [masked]

Below these fields is the 'Scep Configuration' section with 'Scep Status' set to 'disabled' (radio button selected). At the bottom, there are 'Apply' and 'Cancel' buttons. A footer in the bottom left corner reads: 'NetModule Router, Hostname NetModule, Software Version 4.0.0.100, © 2004-2016, NetModule AG'.

Figure 5.62.: Certificate Configuration

This page provides some general configuration options which will be applied when operating on keys and certificates.

If keys, certificates and signing requests are generated locally, the following settings will be taken into account:

| Parameter | Certificate Configuration |
|------------------|---|
| Organisation (O) | The certificate owner's organization |
| Department (OU) | The name of the organizational unit to which the certificate issuer belongs |
| Location (L) | The certificate owner's location |
| State (ST) | The certificate owner's state |
| Country (C) | The certificate owner's country (usually a TLD abbreviation) |
| Common Name (CN) | The certificate owner's common name, mainly used to identify a host |
| E-Mail | The certificate owner's email address |

| Parameter | Certificate Configuration |
|---------------|--|
| Expiry period | The number of days a certificate will be valid from now on |
| Key size | The length of the private key in bits |
| DH primes | The number of bits for custom Diffie-Hellman primes |
| Signature | The signature algorithm when signing certificates |
| Passphrase | The passphrase for accessing/opening a private key |

Please be aware of the fact, that the local random number generator (RNG) provides pretty good randomness for most applications. If stronger cryptography is mandatory, we suggest to create the keys at an external RNG device or manage all certificates completely on a remote certification server. Nevertheless, using a local certificate authority can issue and manage all required certificates and also run a certificate revocation list (CRL).

When importing keys, the certificate and key file can be uploaded individually encoded in PEM/DER or PKCS7 format. All files (CA certificate, certificate and private key) can also be uploaded in one stroke by using the container format PKCS12. RSA/DSS keys can be converted from OpenSSH or Dropbear formats. It is possible to specify the passphrase for opening the private key. Please note that the system will generally apply the system-wide certificate passphrase on a key when installing the certificate. Thus, changing the general passphrase will result in all local keys getting equipped with the new one.

SCEP Configuration

If certificates are getting enrolled by using the Simple Certificate Enrollment Protocol (SCEP) the following settings can be configured:

| Parameter | SCEP Configuration |
|-----------------------|--|
| SCEP status | Specifies whether SCEP is enabled or not |
| URL | The SCEP URL, usually in the form <code>http://<host>/<path>/pkiclient.exe</code> |
| CA fingerprint | The fingerprint of the certificate used to identify the remote authority. If left empty, any CA will be trusted. |
| Fingerprint algorithm | The fingerprint algorithm for identifying the CA (MD5 or SHA1) |
| Poll interval | The polling interval in seconds for a certificate request |
| Request timeout | The max. polling time in seconds for a certificate request |
| ID type | Can be IP, Email or DNS |
| Password | The password for the scep server. |

When enrolling certificates, the CA certificate will be initially fetched from the specified SCEP URL using the `getca` operation. It will be shown on the configuration page and it has to be verified that it belongs to the correct authority. Otherwise, the CA must be rejected. This part is essential when using SCEP as it builds up the chain of trust.

If a certificate enrollment request times out, it is possible to re-trigger the interrupted enrollment request and it will be resumed using the previously generated key. In case a request has been rejected, you are required to erase the certificate first and then start the enrollment process all over again.

Authorities

For SSL client connections (as used by SDK functions or when downloading configuration/software images) you might upload a list of CA certificates which are considered trusted.

To obtain the CA certificate from a particular site with Mozilla Firefox, the following steps will be required:

- Point the browser to the relevant HTTPS website
- Click the padlock in the address bar
- Click the **More Information** and the **View Certificate** button
- Select the **Details** tab press the **Export** button
- Choose a path for the file (e.g. website.pem)

Certificates from self-signed authorities can also be retrieved by running:

```
echo quit | \  
openssl s_client -showcerts -connect <host>:443 | \  
sed -ne '/-BEGIN CERTIFICATE-/,/-END CERTIFICATE-/p' > other.crt
```

The PEM-encoded X.509 certificate files can be edited and concatenated using a simple editor (if required) and then uploaded to the box. Once installed, an SSL client connection will terminate if verification with any of those CA certificates fails.

5.8.9. Licensing

Certain features of NetModule routers require a valid license to be present in the system, some of them also depend on the mounted modules. Please contact us for getting a valid license for available components and we will provide a license file based on your serial number which can be installed to the router afterwards.

The screenshot shows the NetModule web interface. On the left is a 'WEB MANAGER' sidebar with various system management options. The main content area is titled 'License Installation' and includes a 'License file' field with a 'Browse...' button and an 'Install' button. Below this is a 'Licensing Status' section showing the serial number '00112B0114FE' and a message 'A valid license is installed.' At the bottom is a table listing features, their availability, and their licensing status.

| Feature | Availability | Licensing Status |
|----------|--------------|------------------|
| GPS | yes | licensed |
| GSM | yes | licensed |
| LTE | yes | licensed |
| MOBILEIP | yes | licensed |
| SERVER | yes | unlicensed |
| UMTS | yes | licensed |
| VIRT | no | unlicensed |
| VOICE | yes | licensed |
| WLAN | yes | licensed |

Figure 5.63.: Licensing

5.8.10. Legal Notice

OSS Notice

We inform you that NetModule products may contain in part open-source software. We are distributing such open-source software to you under the terms of GNU General Public License (GPL), GNU Lesser General Public License (LGPL) or other open-source licenses.

These licenses allow you to run, copy, distribute, study, change and improve any software covered by GPL, Lesser GPL, or other open-source licenses without any restrictions from us or our end user license agreement on what you may do with that software. Unless required by applicable law or agreed to in writing, software distributed under open-source licenses is distributed on an "AS IS" basis, WITHOUT WARRANTIES OR CONDITIONS OF ANY KIND, either express or implied.

To obtain the corresponding open source codes covered by these licenses, please contact our technical support at router@support.netmodule.com.

Acknowledgements

This product includes PHP, freely available from <http://www.php.net>.

This product includes software developed by the OpenSSL Project for use in the OpenSSL Toolkit (<http://www.openssl.org/>).

This product includes cryptographic software written by Eric Young(ey@cryptsoft.com).

This product includes software written by Tim Hudson (tjh@cryptsoft.com).

This product includes software written Jean-loup Gailly and Mark Adler.

This product includes software MD5 Message-Digest Algorithm by RSA Data Security, Inc.

This product includes an implementation of the AES encryption algorithm based on code released by Dr Brian Gladman.

Multiple-precision arithmetic code originally written by David Ireland

Software from The FreeBSD Project (www.freebsd.org)

Copyright (C) 2020, NetModule. All rights reserved.

5.9. LOGOUT

Please use this menu to log out from the Web Manager.

6. Command Line Interface

The Command Line Interface (CLI) offers a generic control interface to the router and can be used to get/set configuration parameters, apply updates, restart services or perform other system tasks.

It will be started automatically in interactive mode when logging in as *admin* user or by running `cli -i`. However, the same syntax can be used when calling it from the system shell. A list of available commands can be displayed by running `cli -l`.

The CLI supports TAB completion, that is expanding entered words or fragments by hitting the TAB key at any time. This applies to commands but also to some arguments and generally offers a convenient way for working on the shell.

Please note that each CLI session will perform an automatic logout as soon as a certain time of inactivity (10 minutes by default) has been reached. It can be turned off by the command `no-autologout`.

6.1. General Usage

When operating the CLI in interactive mode, each entered command will be executed by the RETURN key. You can use the Left and Right keys to move the current point between entered characters or use the Up and Down keys to search the history of entered commands. Typing `exit` as well as pressing CTRL-c twice or CTRL-d on an empty command line will exit the CLI.

List of supported key sequences:

| Key Sequence | Action |
|--------------|--|
| CTRL-a | Move to the start of the current line |
| CTRL-e | Move to the end of the line |
| CTRL-f | Move forward a character |
| CTRL-b | Move back a character |
| ALT-f | Move forward to the end of the next word |
| ALT-b | Move back to the start of the current or previous word |
| CTRL-l | Clear the screen leaving the current line at the top of the screen; with an argument given, refresh the current line without clearing the screen |
| CTRL-p | Fetch the previous command from the history list, moving back in the list |
| CTRL-n | Fetch the next command from the history list, moving forward in the list |
| ALT-< | Move to the first line in the history |
| ALT-> | Move to the end of the input history |

| Key Sequence | Action |
|--------------|--|
| CTRL-r | Search backward starting at the current line and moving up through the history |
| CTRL-s | Freeze session |
| CTRL-q | Reactivate frozen session |
| CTRL-d | Delete character at point or exit CLI if at the beginning of the line |
| CTRL-t | Drag the character before point forward moving point forward as well; if point is at the end of the line, then this transposes the two characters before the point |
| ALT-t | Drag the word before point past the word after point, moving point over that word as well. If point is at the end of the line, this transposes the last two words on the line. |
| CTRL-k | Delete the text from point to the end of the line |
| CTRL-y | Yank the top of the deleted text into the buffer at point |

Please note, that it can be required to apply quotes (") when entering commands with arguments containing whitespaces.

6.2. Print Help

The `help` command can be used to get the list of available commands when called without arguments, otherwise it will print the usage of the specified command.

```
> help
Usage:
    help [<command>]
```

Available commands:

```

get           Get config parameters
set           Set config parameters
done          Check done
update        Update system facilities
cert          Manage keys and certificates
status        Get status information
scan          Scan networks
send          Send message, mail, techsupport or ussd
restart       Restart service
debug         Debug system
reset         Reset system to factory defaults
reboot        Reboot system
shell         Run shell command
help          Print help for command
no-autologout Turn off auto-logout
history       Show command history
```

`exit``Exit`

6.3. Getting Config Parameters

The `get` command can be used to get configuration values.

```
> get -h
Usage:
    get [-hsvfc] <parameter> [<parameter>..]

Options:
    -s          generate sourceable output
    -v          validate config parameter
    -f          get factory default rather than current value
    -c          show configuration sections
```

6.4. Setting Config Parameters

The `set` command can be used to set configuration values.

```
> set -h
Usage:
    set [-hv] <parameter>=<value> [<parameter>=<value>..]

Options:
    -v          validate config parameter
```

6.5. Checking Config Completed

The `done` command can be used to check if all modify scripts have completed after a config change.

```
> done -h
Usage:
    done [-h]
```

6.6. Getting Status Information

The `status` command can be used to get various status information of the system.

```
> status -h
Usage:
    status [-hs] <section>
```

Options:

`-s` generate sourceable output

Available sections:

| | |
|----------------------------|-------------------------------|
| <code>summary</code> | Short status summary |
| <code>info</code> | System and config information |
| <code>config</code> | Current configuration |
| <code>system</code> | System information |
| <code>configuration</code> | Configuration information |
| <code>license</code> | License information |
| <code>wwan</code> | WWAN module status |
| <code>wlan</code> | WLAN module status |
| <code>gnss</code> | GNSS (GPS) module status |
| <code>eth</code> | Ethernet interface status |
| <code>lan</code> | LAN interface status |
| <code>wan</code> | WAN interface status |
| <code>openvpn</code> | OpenVPN connection status |
| <code>ipsec</code> | IPsec connection status |
| <code>pptp</code> | PPTP connection status |
| <code>gre</code> | GRE connection status |
| <code>dialin</code> | Dial-In connection status |
| <code>mobileip</code> | MobileIP status |
| <code>dio</code> | Digital IO status |
| <code>audio</code> | Audio module status |
| <code>can</code> | CAN module status |
| <code>uart</code> | UART module status |
| <code>ibis</code> | IBIS module status |
| <code>redundancy</code> | Redundancy status |
| <code>sms</code> | SMS status |
| <code>firewall</code> | Firewall status |
| <code>qos</code> | QoS status |
| <code>neigh</code> | Neighborhood status |
| <code>location</code> | Current Location |

6.7. Scanning Networks

The `scan` command can be used to scan for available WWAN and WLAN networks.

```
> scan -h
```

Usage:

```
scan [-hs] <interface>
```

Options:

`-s` generate sourceable output

6.8. Sending E-Mail or SMS

The `send` command can be used to send a message via E-Mail/SMS to the specified address or phone number.

```
> send -h
```

Usage:

```
send [-h] <type> <dest> <msg>
```

Options:

```
<type>    type of message to be sent (mail, sms, techsupport,
ussd)
<dest>    destination of message (mail-address, phone-number or
index)
<msg>     message to be sent
```

6.9. Updating System Facilities

The update command can be used to perform various system updates.

```
> update -h
```

Usage:

```
update [-hfrsn] <software|config|license|sshkeys> <URL>
```

Options:

```
-r    reboot after update
-f    force update
-n    don't reset missing config values with factory defaults
-s    show update status
```

Available update targets:

```
software    Perform software update
firmware    Perform module firmware update
config      Update configuration
license     Update licenses
sshkeys     Install SSH authorized keys
```

You may also run 'update software latest' to install the latest version from our server.

6.10. Manage keys and certificates

The cert command can be used to manage keys and certificates.

```
> cert -h
```

Usage:

```
cert [-h] [-p phrase] <operation> <cert> [<url>]
```

Possible operations:

```
install    install a certificate from specified URL
create     create a certificate locally
```

| | |
|--------|--------------------------------|
| enroll | enroll a certificate via SCEP |
| erase | erase an installed certificate |
| view | view an installed certificate |

6.11. Restarting Services

The restart command can be used to restart system services.

```
> restart -h
Usage:
    restart [-h] <service>
```

Available services:

| | |
|--------------|----------------------|
| configd | Configuration daemon |
| dnsmasq | DNS/DHCP server |
| dropbear | SSH server |
| firewall | Firewall and NAT |
| gpsd | GPS daemon |
| gre | GRE connections |
| ipsec | IPsec connections |
| lighttpd | HTTP server |
| link-manager | WAN links |
| network | Networking |
| openvpn | OpenVPN connections |
| pptp | PPTP connections |
| qos | QoS daemon |
| smsd | SMS daemon |
| snmpd | SNMP daemon |
| surveyor | Supervision daemon |
| syslog | Syslog daemon |
| telnet | Telnet server |
| usbipd | USB/IP daemon |
| voiced | Voice daemon |
| vrrpd | VRRP daemon |
| wlan | WLAN interfaces |
| wwan-manager | WWAN manager |

6.12. Debug System

The debug command can be used to obtain debug/log messages.

```
> debug -h
Usage:
    debug [-h] <target>
```

Available debug targets:

configd

```
event-manager  
home-agent  
led-manager  
link-manager  
mobile-node  
qmid  
qosd  
scripts  
sdkhost  
ser2net  
smsd  
surveyor  
swupdate  
system  
voiced  
watchdog  
wwan-manager  
wwanmd
```

6.13. Resetting System

The `reset` command can be used to reset the router back to factory defaults.

```
> reset -h  
Usage:  
    reset [-h]
```

6.14. Rebooting System

The `reboot` command can be used to reboot the router.

```
> reboot -h  
Usage:  
    reboot [-h]
```

6.15. Running Shell Commands

The `shell` command can be used to execute a system shell and run any arbitrary application or script.

```
> shell -h  
Usage:  
    shell [-h] [<cmd>]
```

6.16. Working with History

The `history` command will print the list of entered commands on a per-user basis.

```
> history -h
Usage:
    history [-c]
```

It can be cleared by `history -c`.

6.17. CLI-PHP

CLI-PHP, the HTTP frontend to the CLI application, can be used to configure and control the router remotely. It is enabled in factory configuration, thus can be used for deployment purposes, but disabled as soon as the admin account has been set up.

The service can later be turned on/off by setting the `cliphp.status` configuration parameter:

```
cliphp.status=0      Service is disabled
cliphp.status=1      Service is enabled
```

This section describes the CLI-PHP interface for Version 2. It accepts POST and GET requests. Running with GET requests, the general usage is defined as follows:

```
Usage:
  http(s)://cli.php?<key1>=<value1>&<key2>=<value2>..<keyN>=<valueN>
```

Available keys:

```
output      Output format (html, plain)
usr         Username to be used for authentication
pwd        Password to be used for authentication
command     Command to be executed
arg0..arg31 Arguments passed to commands
```

Notes:

The commands correspond to CLI commands as seen by `'cli -l'`, the arguments (`arg0..arg31`) will be directly passed to `cli`.

Thus, an URL containing the following sequence:

```
command=get&arg0=admin.password&arg1=admin.debug&arg2=admin.access
```

will lead to `cli` being called as:

```
cli get "admin.password" "admin.debug" "admin.access"
```

It supports whitespaces but please be aware that any special characters in

the URL must be specified according to RFC1738 (usually done by common clients such as wget, lynx, curl).

Response:

The returned response will always contain a status line in the format:

```
<return>: <msg>
```

with return values of OK if succeeded and ERROR if failed. Any output from the commands will be appended.

Examples:

```
OK: status command successful
ERROR: authentication failed
```

status - Display status information

Key usage:

```
command=status[&arg0=<section>]
```

Notes:

Available sections can be retrieved by running
command=status&arg0=-h.
Please note that the status summary can be displayed without authentication.

Examples:

```
http://192.168.1.1/cli.php?version=2&output=html&usr=admin&pwd=admin01&command=status&arg0=-h
```

```
http://192.168.1.1/cli.php?version=2&output=html&usr=admin&pwd=admin01&command=status&arg0=summary
```

```
http://192.168.1.1/cli.php?version=2&output=html&command=status
```

get - Get configuration parameter

Key usage:

```
command=get&arg0=<config-key>[&arg1=<config-key>..]
```

Examples:

```
http://192.168.1.1/cli.php?version=2&output=html&usr=admin&pwd=admin01&command=get&arg0=config.version
```

```
http://192.168.1.1/cli.php?version=2&output=html&usr=admin&pwd=admin01&command=get&arg0=openvpn.status&arg1=snmp.status&arg2=ipsec.status
```

set - Set configuration parameter

Key usage:

```
command=set&arg0=<config-key>&arg1=<config-value>[&arg2=<config-key>&
arg3=<config-value>..]
```

Notes:

In contrast to the other commands, this command requires a set of tuples because of the reserved '=' char, i.e.
[arg0=key0, arg1=val0], [arg2=key1, arg3=val1], [arg4=key2, arg5=val2], etc

Examples:

```
http://192.168.1.1/cli.php?version=2&output=html&usr=admin&pwd=admin01&
command=set&arg0=snmp.status&arg1=1
```

```
http://192.168.1.1/cli.php?version=2&output=html&usr=admin&pwd=admin01&
command=set&arg0=snmp.status&arg1=0&arg2=openvpn.status&arg3=1
```

restart - Restart a system service

Key usage:

```
command=restart&arg0=<service>
```

Notes:

Available services can be retrieved by running 'command=restart&arg0=-h'

Examples:

```
http://192.168.1.1/cli.php?version=2&output=html&usr=admin&pwd=admin01&
command=restart&arg0=-h
```

```
http://192.168.1.1/cli.php?version=2&output=html&usr=admin&pwd=admin01&
command=restart&arg0=link-manager
```

reboot - Trigger system reboot

Key usage:

```
command=reboot
```

Examples:

```
http://192.168.1.1/cli.php?version=2&output=html&usr=admin&pwd=admin01&
command=reboot
```

reset - Run factory reset

Key usage:

```
command=reset
```

Examples:

```
http://192.168.1.1/cli.php?version=2&output=html&usr=admin&pwd=admin01&command=reset
```

update - Update system facilities

Key usage:

```
command=update&arg0=<facility>&arg1=<URL>
```

Notes:

Available facilities can be retrieved by running 'command=update&arg0=-h'

Examples:

```
http://192.168.1.1/cli.php?version=2&output=html&usr=admin&pwd=admin01&command=update&arg0=software&arg1=tftp://192.168.1.254/latest
```

```
http://192.168.1.1/cli.php?version=2&output=html&usr=admin&pwd=admin01&command=update&arg0=config&arg1=tftp://192.168.1.254/user-config.zip
```

```
http://192.168.1.1/cli.php?version=2&output=html&usr=admin&pwd=admin01&command=update&arg0=license&arg1=http://192.168.1.254/xxx.lic
```

```
http://192.168.1.1/cli.php?version=2&output=html&usr=admin&pwd=admin01&command=update&arg0=firmware&arg1=wwan0&arg2=tftp://192.168.1.254/firmware
```

send - Send SMS

Key usage:

```
command=send&arg0=sms&arg1=<number>&arg2=<text>
```

Notes:

The phone number has to be specified in international format such as +123456789 including a leading plus sign (which can be encoded with %2B). The SMS daemon must be properly configured prior to using that function.

Examples:

```
http://192.168.1.1/cli.php?version=2&output=html&usr=admin&pwd=admin01&command=send&arg0=sms&arg1=%2B123456789&arg2=test
```

send - Send E-Mail

Key usage:

```
command=send&arg0=mail&arg1=<address>&arg2=<text>
```

Notes:

The address has to be a valid E-Mail address such as abc@abc.com (the at-sign can be encoded with %40). The E-Mail client must be properly configured prior to using that function.

Examples:

```
http://192.168.1.1/cli.php?version=2&output=html&usr=admin&pwd=admin01&command=send&arg0=mail&arg1=abc%40abc.com&arg2=test
```

send - Send TechSupport

Key usage:

```
command=send&arg0=techsupport&arg1=stdout  
command=send&arg0=techsupport&arg1=<address>&arg2=<subject>
```

Notes:

The address has to be a valid E-Mail address such as abc@abc.com (the at-sign can be encoded with %40). The E-Mail client must be properly configured prior to using that function.

In case of stdout, the downloaded techsupport file will be called 'download'.

Examples:

```
http://192.168.1.1/cli.php?version=2&output=mime&usr=admin&pwd=admin01&command=send&arg0=techsupport&arg1=stdout  
http://192.168.1.1/cli.php?version=2&output=html&usr=admin&pwd=admin01&command=send&arg0=techsupport&arg1=abc%40abc.com&arg2=subject
```

send - Send USSD code

Key usage:

```
command=send&arg0=ussd&arg1=<card>&arg2=<code>
```

Notes:

The argument card specifies the card module index (e.g. 0 for wwan0). The USSD code can consist of digits, plus signs, asterisks (can be encoded with %2A) and dashes (can be encoded with %23).

Examples:

```
http://192.168.1.1/cli.php?version=2&output=html&usr=admin&pwd=admin01&command=send&arg0=ussd&arg1=0&arg2=%2A100%23
```

A. Appendix

A.1. Abbreviations

| Parameter | Description |
|-----------------------|---|
| ETH _x | Corresponds to Ethernet interfaces (either single or switched ones) |
| LAN _x | LAN interfaces which are generally based on Ethernet interfaces (including bridges) |
| WLAN _x | Refers to a Wireless LAN interface which will be represented as additional LAN interface when configured as access point |
| WWAN _x | Refers to a Wireless Wide Area Network (2G/3G/4G) connection |
| TUN _x | Specifies an OpenVPN tunnel interface (based on TUN) |
| TAP _x | Specifies an OpenVPN tunnel interface (based on TAP) |
| PPTP _x | Specifies a PPTP tunnel interface |
| MOBILEIP _x | Refers to a Mobile IP tunnel interface |
| SIM _x | Specifies the SIM slot as seen on the front panel |
| GNSS _x | Specifies a Global Navigation Satellite System module |
| Mobile _x | Identifies a WWAN modem |
| SERIAL _x | Identifies a serial port |
| OUT _x | Specifies a digital I/O output port (DO _x) |
| IN _x | Specifies a digital I/O input port (DI _x) |
| ANY | Generally includes all options offered by the current section |
| APN | Access Point Name |
| CID | A Cell ID is a generally unique number used to identify each Base Transceiver Station (BTS). |
| LAC | The Location Area Code corresponds to an identifier of a set of base stations that are grouped together to optimize signaling |
| LAI | The Location Area Identity is a globally unique number that identifies the country, network provider and location area |
| MSS | Maximum Segment Size |
| MTU | Maximum Transmission Unit |
| DNS | Domain Name System |
| NAPT | Network Address and Port Translation |

| Parameter | Description |
|-----------|--|
| DHCP | Dynamic Host Configuration Protocol |
| SDK | Script Development Kit which can be used to program applications |
| CLI | Command Line Interface, a generic interface to query the router or perform system tasks |
| SIM | Subscriber Identity Module |
| SMS | Short Message Service |
| SSID | Service Set Identifiers, can be used to define multiple WLAN networks on a module |
| STP | Spanning Tree Protocol |
| USSD | Unstructured Supplementary Service Data |
| VRRP | Virtual Router Redundancy Protocol |
| VPN | Virtual Private Network |
| WAN | WAN links include all Wide Area Network interfaces which are currently activated in the system |
| FQDN | Fully qualified domain name |
| ASU | Arbitrary Strength Unit |
| RSRP | Referenz Signal Received Power |
| RSRQ | Reference Signal Received Quality |
| LAI | Location Area Identification |
| LAC | Location Area Code |
| MCC | Mobile Country Code |
| MNC | Mobile Network Code |
| CID | Cell-ID |
| MSISDN | Mobile Subscriber Integrated Services Digital Network Number |
| ICCID | Integrated Circuit Card Identifier |
| MEID | Mobile Equipment Identifier |
| IMSI | International Mobile Subscriber Identity |
| IMEI | International Mobile Station Equipment Identity |

Table A.1.: Abbreviations

In general, internal interfaces are written lower-case and may have a different naming. Their index starts from zero, whereas interfaces seen by the user will be written in capital letters

starting from one.

A.2. System Events

| ID | Event | Description |
|-----|------------------------|--------------------------------|
| 101 | wan-up | WAN link came up |
| 102 | wan-down | WAN link went down |
| 201 | dio-in1-on | DIO IN1 turned on |
| 202 | dio-in1-off | DIO IN1 turned off |
| 203 | dio-in2-on | DIO IN2 turned on |
| 204 | dio-in2-off | DIO IN2 turned off |
| 205 | dio-out1-on | DIO OUT1 turned on |
| 206 | dio-out1-off | DIO OUT1 turned off |
| 207 | dio-out2-on | DIO OUT2 turned on |
| 208 | dio-out2-off | DIO OUT2 turned off |
| 301 | gps-up | GPS signal is available |
| 302 | gps-down | GPS signal is not available |
| 401 | openvpn-up | OpenVPN connection came up |
| 402 | openvpn-down | OpenVPN connection went down |
| 403 | ipsec-up | IPsec connection came up |
| 404 | ipsec-down | IPsec connection went down |
| 406 | pptp-up | PPTP connection came up |
| 407 | pptp-down | PPTP connection went down |
| 408 | dialin-up | Dial-In connection came up |
| 409 | dialin-down | Dial-In connection went down |
| 410 | mobileip-up | Mobile IP connection came up |
| 411 | mobileip-down | Mobile IP connection went down |
| 412 | gre-up | GRE connection came up |
| 413 | gre-down | GRE connection went down |
| 501 | system-login-failed | User login failed |
| 502 | system-login-succeeded | User login succeeded |
| 503 | system-logout | User logged out |

| ID | Event | Description |
|------|-----------------------|--|
| 504 | system-rebooting | System reboot has been triggered |
| 505 | system-startup | System has been started |
| 506 | test | test event |
| 507 | sdk-startup | SDK has been started |
| 508 | system-time-updated | System time has been updated |
| 509 | system-poweroff | System poweroff has been triggered |
| 510 | system-error | System is in error state |
| 511 | system-no-error | System left error state |
| 601 | sms-sent | SMS has been sent |
| 602 | sms-notsent | SMS has not been sent |
| 603 | sms-received | SMS has been received |
| 604 | sms-report-received | SMS report has been received |
| 701 | call-incoming | A voice call is coming in |
| 702 | call-outgoing | Outgoing voice call is being established |
| 801 | ddns-update-succeeded | Dynamic DNS update succeeded |
| 802 | ddns-update-failed | Dynamic DNS update failed |
| 901 | usb-storage-added | USB storage device has been added |
| 902 | usb-storage-removed | USB storage device has been removed |
| 903 | usb-eth-added | USB Ethernet device has been added |
| 904 | usb-eth-removed | USB Ethernet device has been removed |
| 905 | usb-serial-added | USB serial device has been added |
| 906 | usb-serial-removed | USB serial device has been removed |
| 1001 | redundancy-master | System is now master router |
| 1002 | redundancy-backup | System is now backup router |

Table A.2.: System Events

A.3. Factory Configuration

The factory configuration including default values for any configuration parameter can be derived from the file `/etc/config/factory-config.cfg` on the router. You may also call `cli get -f <parameter>` for obtaining a specific default value.

A.4. SNMP VENDOR MIB

```

-- *****
-- NetModule AG VENDOR MIB
--
--
-- (c) COPYRIGHT 2020 by NetModule AG, Switzerland
-- All rights reserved.
--
-- *****

NB-MIB DEFINITIONS ::= BEGIN

-- *****
-- imports
-- *****

IMPORTS
    MODULE-IDENTITY, OBJECT-TYPE, NOTIFICATION-TYPE,
    Integer32, Counter32, Gauge32,
    Counter64, TimeTicks
        FROM SNMPv2-SMI
    TEXTUAL-CONVENTION, DisplayString,
    PhysAddress, TruthValue, RowStatus, DateAndTime,
    TimeStamp, AutonomousType, TestAndIncr
        FROM SNMPv2-TC
    MODULE-COMPLIANCE, OBJECT-GROUP
        FROM SNMPv2-CONF
    snmpTraps
        FROM SNMPv2-MIB
    URLString
        FROM NETWORK-SERVICES-MIB
    enterprises
        FROM SNMPv2-SMI;

-- *****
-- module definition
-- *****

nb MODULE-IDENTITY
    LAST-UPDATED "201806261330Z"
    ORGANIZATION "NetModule AG"
    CONTACT-INFO
        "NetModule AG, Switzerland"
    DESCRIPTION
        "MIB module which defines the NB router specific entities"

    REVISION "201806261330Z"
    DESCRIPTION
        "MIB for software release 4.1"

    REVISION "201610181200Z"
    DESCRIPTION
        "MIB for software release 4.0"

    REVISION "201607121200Z"
    DESCRIPTION
        "MIB for software release 4.0"

    REVISION "201603021200Z"
    DESCRIPTION
        "MIB for software release 3.9"

    REVISION "201411241000Z"
    DESCRIPTION
        "MIB for software release 3.8"

    REVISION "201405091000Z"
    DESCRIPTION
        "MIB for software release 3.7"

    REVISION "201212191000Z"
    DESCRIPTION
        "MIB for software release 3.6"
    ::= { netmodule 10 }

-- *****
-- root anchor
-- *****

netmodule OBJECT IDENTIFIER ::= { enterprises 31496 }

-- *****
-- table definitions
-- *****

system OBJECT IDENTIFIER ::= { nb 1 }
products OBJECT IDENTIFIER ::= { nb 10 }
admin OBJECT IDENTIFIER ::= { nb 40 }

```

```

dio          OBJECT IDENTIFIER ::= { nb 53 }
sdk          OBJECT IDENTIFIER ::= { nb 90 }
traps       OBJECT IDENTIFIER ::= { nb 100 }

-- *****

nb1600      OBJECT IDENTIFIER ::= { products 46 }
nb2700      OBJECT IDENTIFIER ::= { products 47 }
nb3700      OBJECT IDENTIFIER ::= { products 48 }
nb2710      OBJECT IDENTIFIER ::= { products 51 }
nb3710      OBJECT IDENTIFIER ::= { products 52 }
nb3720      OBJECT IDENTIFIER ::= { products 53 }
nb2800      OBJECT IDENTIFIER ::= { products 54 }
nb3701      OBJECT IDENTIFIER ::= { products 55 }
nb3711      OBJECT IDENTIFIER ::= { products 56 }
nb3800      OBJECT IDENTIFIER ::= { products 57 }
nb800       OBJECT IDENTIFIER ::= { products 58 }

-- *****
-- NAdminTable
-- *****

swVersion OBJECT-TYPE
    SYNTAX      DisplayString
    MAX-ACCESS  read-only
    STATUS      current
    DESCRIPTION
        "The currently installed system software version"
    ::= { admin 1 }

kernelVersion OBJECT-TYPE
    SYNTAX      DisplayString
    MAX-ACCESS  read-only
    STATUS      current
    DESCRIPTION
        "The currently installed kernel version"
    ::= { admin 2 }

serialNumber OBJECT-TYPE
    SYNTAX      DisplayString
    MAX-ACCESS  read-only
    STATUS      current
    DESCRIPTION
        "The serial number of the device"
    ::= { admin 3 }

configDesc OBJECT-TYPE
    SYNTAX      DisplayString
    MAX-ACCESS  read-only
    STATUS      current
    DESCRIPTION
        "The description of the current configuration"
    ::= { admin 4 }

configHash OBJECT-TYPE
    SYNTAX      DisplayString
    MAX-ACCESS  read-only
    STATUS      current
    DESCRIPTION
        "The hash of the current configuration"
    ::= { admin 5 }

softwareHash OBJECT-TYPE
    SYNTAX      DisplayString
    MAX-ACCESS  read-only
    STATUS      current
    DESCRIPTION
        "The hash of the current software"
    ::= { admin 6 }

systemStatus OBJECT-TYPE
    SYNTAX      INTEGER {
        ok (1),
        degraded (2),
        outoforder (3)
    }
    MAX-ACCESS  read-only
    STATUS      current
    DESCRIPTION
        "The global system status"
    ::= { admin 7 }

systemError OBJECT-TYPE
    SYNTAX      DisplayString
    MAX-ACCESS  read-only
    STATUS      current
    DESCRIPTION
        "A comma-separated list of services which are in error state"
    ::= { admin 8 }

```



```

systemDate OBJECT-TYPE
  SYNTAX      DateAndTime
  MAX-ACCESS  read-only
  STATUS      current
  DESCRIPTION
    "The current local date and time of day."
  ::= { admin 9 }

deviceRestart OBJECT-TYPE
  SYNTAX INTEGER {
    restart (1)
  }
  MAX-ACCESS  read-write
  STATUS      current
  DESCRIPTION
    "Force a device restart"
  ::= { admin 10 }

-- Update --

updateOperation OBJECT-TYPE
  SYNTAX INTEGER {
    update (0),
    store (1)
  }
  MAX-ACCESS  read-write
  STATUS      current
  DESCRIPTION
    "The desired operation for configuration or software updates"
  ::= { admin 11 }

switchOperation OBJECT-TYPE
  SYNTAX INTEGER {
    software (0),
    config (1)
  }
  MAX-ACCESS  read-write
  STATUS      current
  DESCRIPTION
    "The operation trigger to switch to alternative software or configuration"
  ::= { admin 12 }

softwareActivationDate OBJECT-TYPE
  SYNTAX      DateAndTime
  MAX-ACCESS  read-write
  STATUS      current
  DESCRIPTION
    "The date and time when the alternative software shall be activated"
  ::= { admin 13 }

configActivationDate OBJECT-TYPE
  SYNTAX      DateAndTime
  MAX-ACCESS  read-write
  STATUS      current
  DESCRIPTION
    "The date and time when the alternative configuration shall be activated"
  ::= { admin 14 }

softwareActivatedDate OBJECT-TYPE
  SYNTAX      DateAndTime
  MAX-ACCESS  read-write
  STATUS      current
  DESCRIPTION
    "The Date and Time when the current running software was booted the first time"
  ::= { admin 15 }

-- Configuration Update --

configUpdate OBJECT-TYPE
  SYNTAX      URLString
  MAX-ACCESS  read-write
  STATUS      current
  DESCRIPTION
    "Update the system configuration from the specified URL,
    the URL must be preceded by a valid prefix (e.g. tftp://, sftp://, ftp://, https:// or http://)
    and either point to the update package or to a server directory which
    contains a file named <serial-number>.zip"
  ::= { admin 20 }

configUpdateStatus OBJECT-TYPE
  SYNTAX INTEGER {
    stored (0),
    succeeded (1),
    failed (2),
    inprogress (3),
    notstarted (4)
  }
  MAX-ACCESS  read-only
  STATUS      current
  DESCRIPTION

```

```

    "The status of the last configuration update cycle"
    ::= { admin 21 }

configUpdateError OBJECT-TYPE
    SYNTAX      Integer32
    MAX-ACCESS  read-only
    STATUS      current
    DESCRIPTION
        "The error code of the last configuration update"
    ::= { admin 22 }

configUpdated OBJECT-TYPE
    SYNTAX      DateAndTime
    MAX-ACCESS  read-only
    STATUS      current
    DESCRIPTION
        "The date of the last configuration update"
    ::= { admin 23 }

configUpdateMode OBJECT-TYPE
    SYNTAX      INTEGER {
        full (0),
        partial (1)
    }
    MAX-ACCESS  read-write
    STATUS      current
    DESCRIPTION
        "The desired system configuration update mode (full or partial)"
    ::= { admin 24 }

-- Software Update --

softwareUpdate OBJECT-TYPE
    SYNTAX      URLString
    MAX-ACCESS  read-write
    STATUS      current
    DESCRIPTION
        "Update the system software from the specified URL,
         the URL must be preceded by a valid prefix (e.g. tftp://, sftp://, ftp://, https:// or http://)
         and point to the to be installed image"
    ::= { admin 25 }

softwareUpdateStatus OBJECT-TYPE
    SYNTAX      INTEGER {
        stored (0),
        succeeded (1),
        failed (2),
        inprogress (3),
        notstarted (4)
    }
    MAX-ACCESS  read-only
    STATUS      current
    DESCRIPTION
        "The status of the last software update cycle"
    ::= { admin 26 }

softwareUpdateError OBJECT-TYPE
    SYNTAX      Integer32
    MAX-ACCESS  read-only
    STATUS      current
    DESCRIPTION
        "The error code of the last software update"
    ::= { admin 27 }

softwareUpdated OBJECT-TYPE
    SYNTAX      DateAndTime
    MAX-ACCESS  read-only
    STATUS      current
    DESCRIPTION
        "The date of the last software update"
    ::= { admin 28 }

-- Alternative Configuration --

altConfigDesc OBJECT-TYPE
    SYNTAX      DisplayString
    MAX-ACCESS  read-only
    STATUS      current
    DESCRIPTION
        "The description of the alternative configuration"
    ::= { admin 30 }

altConfigHash OBJECT-TYPE
    SYNTAX      DisplayString
    MAX-ACCESS  read-only
    STATUS      current
    DESCRIPTION
        "The hash of the alternative configuration"
    ::= { admin 31 }

```

```

altConfigUpdated OBJECT-TYPE
    SYNTAX      DateAndTime
    MAX-ACCESS  read-only
    STATUS      current
    DESCRIPTION
        "The date of the last alternative configuration update"
    ::= { admin 32 }

-- Alternative Software --

altSoftwareVersion OBJECT-TYPE
    SYNTAX      DisplayString
    MAX-ACCESS  read-only
    STATUS      current
    DESCRIPTION
        "The version of the alternative software"
    ::= { admin 35 }

altSoftwareHash OBJECT-TYPE
    SYNTAX      DisplayString
    MAX-ACCESS  read-only
    STATUS      current
    DESCRIPTION
        "The hash of the alternative software"
    ::= { admin 36 }

altSoftwareUpdated OBJECT-TYPE
    SYNTAX      DateAndTime
    MAX-ACCESS  read-only
    STATUS      current
    DESCRIPTION
        "The date of the last alternative software update"
    ::= { admin 37 }

-- Upload Syslog --

syslogUpload OBJECT-TYPE
    SYNTAX      URLString
    MAX-ACCESS  read-write
    STATUS      current
    DESCRIPTION
        "Upload the current system logs to the specified URL,
         the URL must be preceded by a valid prefix (e.g. tftp://, sftp://, ftp://, https:// or http://)
         and point to the path where the system log shall be stored."
    ::= { admin 40 }

syslogUploadStatus OBJECT-TYPE
    SYNTAX      INTEGER {
        succeeded (1),
        failed (2),
        inprogress (3),
        notstarted (4)
    }
    MAX-ACCESS  read-only
    STATUS      current
    DESCRIPTION
        "The status of the last syslog upload cycle"
    ::= { admin 41 }

-- Upload Config --

configUpload OBJECT-TYPE
    SYNTAX      URLString
    MAX-ACCESS  read-write
    STATUS      current
    DESCRIPTION
        "Upload the current configuration to the specified URL,
         the URL must be preceded by a valid prefix (e.g. tftp://, sftp://, ftp://, https:// or http://)
         and point to the path where the config shall be stored."
    ::= { admin 42 }

configUploadStatus OBJECT-TYPE
    SYNTAX      INTEGER {
        succeeded (1),
        failed (2),
        inprogress (3),
        notstarted (4)
    }
    MAX-ACCESS  read-only
    STATUS      current
    DESCRIPTION
        "The status of the last config upload cycle"
    ::= { admin 43 }

-- *****
-- NBWwanTable
-- *****

nbWwanTable OBJECT-TYPE
    SYNTAX      SEQUENCE OF NBWwanEntry

```

```

MAX-ACCESS not-accessible
STATUS current
DESCRIPTION "The table describing any WWAN modems and their current settings"
::= { nb 50 }

nbWwanEntry OBJECT-TYPE
SYNTAX NBWwanEntry
MAX-ACCESS not-accessible
STATUS current
DESCRIPTION "An entry describing a WWAN modem and its current settings"
INDEX { wwanModemIndex }
::= { nbWwanTable 1 }

NBWwanEntry ::= SEQUENCE {
    wwanModemIndex Integer32,
    wwanModemName DisplayString,
    wwanModemType DisplayString,
    wwanServiceType DisplayString,
    wwanRegistrationState DisplayString,
    wwanSignalStrength Integer32,
    wwanNetworkName DisplayString,
    wwanLocalAreaIdentification DisplayString,
    wwanLocalAreaCode DisplayString,
    wwanCellId DisplayString,
    wwanTemperature DisplayString,
    wwanIccid DisplayString,
    wwanRSRP DisplayString,
    wwanRSRQ DisplayString,
    wwanSINR DisplayString,
    wwanRSCP DisplayString,
    wwanECIO DisplayString,
    wwanSignalLevel Integer32,
    wwanSignalQuality DisplayString
}

wwanModemIndex OBJECT-TYPE
SYNTAX Integer32(0..254)
MAX-ACCESS not-accessible
STATUS current
DESCRIPTION
    "WWAN modem index"
::= { nbWwanEntry 1 }

wwanModemName OBJECT-TYPE
SYNTAX DisplayString
MAX-ACCESS read-only
STATUS current
DESCRIPTION
    "WWAN modem name"
::= { nbWwanEntry 2 }

wwanModemType OBJECT-TYPE
SYNTAX DisplayString
MAX-ACCESS read-only
STATUS current
DESCRIPTION
    "WWAN modem type"
::= { nbWwanEntry 3 }

wwanServiceType OBJECT-TYPE
SYNTAX DisplayString
MAX-ACCESS read-only
STATUS current
DESCRIPTION
    "The current service type of the WWAN modem"
::= { nbWwanEntry 4 }

wwanRegistrationState OBJECT-TYPE
SYNTAX DisplayString
MAX-ACCESS read-only
STATUS current
DESCRIPTION
    "The current registration state of the WWAN modem"
::= { nbWwanEntry 5 }

wwanSignalStrength OBJECT-TYPE
SYNTAX Integer32
MAX-ACCESS read-only
STATUS current
DESCRIPTION
    "The current signal strength of the WWAN modem (-999 means unknown)"
::= { nbWwanEntry 6 }

wwanNetworkName OBJECT-TYPE
SYNTAX DisplayString
MAX-ACCESS read-only
STATUS current
DESCRIPTION
    "The network name to which the WWAN modem is currently registered"
::= { nbWwanEntry 7 }

```

```

wanLocalAreaIdentification OBJECT-TYPE
    SYNTAX      DisplayString
    MAX-ACCESS  read-only
    STATUS      current
    DESCRIPTION
        "The Local Area Identification (LAI) to which the WWAN modem is currently registered"
    ::= { nbWwanEntry 8 }

wanLocalAreaCode OBJECT-TYPE
    SYNTAX      DisplayString
    MAX-ACCESS  read-only
    STATUS      current
    DESCRIPTION
        "The Local Area Code (LAC) to which the WWAN modem is currently registered"
    ::= { nbWwanEntry 9 }

wanCellId OBJECT-TYPE
    SYNTAX      DisplayString
    MAX-ACCESS  read-only
    STATUS      current
    DESCRIPTION
        "The Cell ID (CID) to which the WWAN modem is currently registered"
    ::= { nbWwanEntry 10 }

wanTemperature OBJECT-TYPE
    SYNTAX      DisplayString
    MAX-ACCESS  read-only
    STATUS      current
    DESCRIPTION
        "The current temperature of the WWAN modem"
    ::= { nbWwanEntry 11 }

wanIccid OBJECT-TYPE
    SYNTAX      DisplayString
    MAX-ACCESS  read-only
    STATUS      current
    DESCRIPTION
        "The Integrated Circuit Card Identifier (ICCID) of the SIM connected to the WWAN modem"
    ::= { nbWwanEntry 12 }

wanRSRP OBJECT-TYPE
    SYNTAX      DisplayString
    UNITS       "dBm"
    MAX-ACCESS  read-only
    STATUS      current
    DESCRIPTION "The current Reference Signal Received Power (LTE) of the WWAN modem"
    ::= { nbWwanEntry 13 }

wanRSRQ OBJECT-TYPE
    SYNTAX      DisplayString
    UNITS       "dB"
    MAX-ACCESS  read-only
    STATUS      current
    DESCRIPTION "The current Reference Signal Received Quality (LTE) of the WWAN modem"
    ::= { nbWwanEntry 14 }

wanSINR OBJECT-TYPE
    SYNTAX      DisplayString
    UNITS       "dB"
    MAX-ACCESS  read-only
    STATUS      current
    DESCRIPTION "The current Signal to interference plus noise ratio (LTE) of the WWAN modem"
    ::= { nbWwanEntry 15 }

wanRSCP OBJECT-TYPE
    SYNTAX      DisplayString
    UNITS       "dBm"
    MAX-ACCESS  read-only
    STATUS      current
    DESCRIPTION "The current Received Signal Code Power (UMTS) of the WWAN modem"
    ::= { nbWwanEntry 16 }

wanECIO OBJECT-TYPE
    SYNTAX      DisplayString
    UNITS       "dB"
    MAX-ACCESS  read-only
    STATUS      current
    DESCRIPTION "The current ratio of Received power of the carrier to the all over Noise (UMTS) of the WWAN modem←"
    ::= { nbWwanEntry 17 }

wanSignalLevel OBJECT-TYPE
    SYNTAX      Integer32
    MAX-ACCESS  read-only
    STATUS      current
    DESCRIPTION "The current signal level of the WWAN modem"
    ::= { nbWwanEntry 18 }

wanSignalQuality OBJECT-TYPE

```

```

SYNTAX      DisplayString
MAX-ACCESS  read-only
STATUS      current
DESCRIPTION "The current signal quality of the WWAN modem"
 ::= { nbWwanEntry 19 }

-- *****
-- NBGnssTable
-- *****

nbGnssTable OBJECT-TYPE
SYNTAX      SEQUENCE OF NBGnssEntry
MAX-ACCESS  not-accessible
STATUS      current
DESCRIPTION
 "The table describing any GNSS devices and their current settings"
 ::= { nb 51 }

nbGnssEntry OBJECT-TYPE
SYNTAX      NBGnssEntry
MAX-ACCESS  not-accessible
STATUS      current
DESCRIPTION
 "An entry describing a GNSS device and its current settings"
INDEX       { gnssIndex }
 ::= { nbGnssTable 1 }

NBGnssEntry ::= SEQUENCE {
    gnssIndex Integer32,
    gnssName DisplayString,
    gnssSystem DisplayString,
    gnssLat DisplayString,
    gnssLon DisplayString,
    gnssAlt DisplayString,
    gnssNumSat Integer32,
    gnssNumSatUsed Integer32,
    gnssHorizontalSpeed DisplayString,
    gnssVerticalSpeed DisplayString,
    gnssTrackAngle DisplayString
}

gnssIndex OBJECT-TYPE
SYNTAX      Integer32(0..254)
MAX-ACCESS  not-accessible
STATUS      current
DESCRIPTION
 "GNSS device index"
 ::= { nbGnssEntry 1 }

gnssName OBJECT-TYPE
SYNTAX      DisplayString
MAX-ACCESS  read-only
STATUS      current
DESCRIPTION
 "GNSS device name"
 ::= { nbGnssEntry 2 }

gnssSystem OBJECT-TYPE
SYNTAX      DisplayString
MAX-ACCESS  read-only
STATUS      current
DESCRIPTION
 "GNSS system used by the device"
 ::= { nbGnssEntry 3 }

gnssLat OBJECT-TYPE
SYNTAX      DisplayString
MAX-ACCESS  read-only
STATUS      current
DESCRIPTION
 "The current latitude value received by the GNSS device"
 ::= { nbGnssEntry 4 }

gnssLon OBJECT-TYPE
SYNTAX      DisplayString
MAX-ACCESS  read-only
STATUS      current
DESCRIPTION
 "The current longitude value received by the GNSS device"
 ::= { nbGnssEntry 5 }

gnssAlt OBJECT-TYPE
SYNTAX      DisplayString
MAX-ACCESS  read-only
STATUS      current
DESCRIPTION
 "The current altitude value received by the GNSS device"
 ::= { nbGnssEntry 6 }

gnssNumSat OBJECT-TYPE

```

```

SYNTAX      Integer32
MAX-ACCESS  read-only
STATUS      current
DESCRIPTION
    "The current number of satellites in view for the GNSS device"
 ::= { nbGnssEntry 7 }

gnssNumSatUsed OBJECT-TYPE
SYNTAX      Integer32
MAX-ACCESS  read-only
STATUS      current
DESCRIPTION
    "The current number of used satellites for the GNSS device"
 ::= { nbGnssEntry 8 }

gnssHorizontalSpeed OBJECT-TYPE
SYNTAX      DisplayString
MAX-ACCESS  read-only
STATUS      current
DESCRIPTION
    "The current horizontal speed over the ground value in meter per second received by the GNSS device"
 ::= { nbGnssEntry 9 }

gnssVerticalSpeed OBJECT-TYPE
SYNTAX      DisplayString
MAX-ACCESS  read-only
STATUS      current
DESCRIPTION
    "The current vertical speed value in meter per second received by the GNSS device"
 ::= { nbGnssEntry 10 }

gnssTrackAngle OBJECT-TYPE
SYNTAX      DisplayString
MAX-ACCESS  read-only
STATUS      current
DESCRIPTION
    "The current track angle value in degrees received by the GNSS device"
 ::= { nbGnssEntry 11 }

-- *****
-- NBWlanTable
-- *****

nbWlanTable OBJECT-TYPE
SYNTAX      SEQUENCE OF NBWlanEntry
MAX-ACCESS  not-accessible
STATUS      current
DESCRIPTION
    "A table describing any WLAN modems and their current settings."
 ::= { nb 60 }

nbWlanEntry OBJECT-TYPE
SYNTAX      NBWlanEntry
MAX-ACCESS  not-accessible
STATUS      current
DESCRIPTION
    "An entry describing a WLAN modem and its current settings."
INDEX       { wlanModuleIndex }
 ::= { nbWlanTable 1 }

NBWlanEntry ::= SEQUENCE {
    wlanModuleIndex Integer32,
    wlanModuleName DisplayString,
    wlanModuleType DisplayString,
    wlanNumClients Integer32,
    wlanModuleChannel Integer32,
    wlanModuleFrequency Integer32,
    wlanSignalStrength Integer32
}

wlanModuleIndex OBJECT-TYPE
SYNTAX      Integer32 (0..254)
MAX-ACCESS  not-accessible
STATUS      current
DESCRIPTION
    "WLAN module index"
 ::= { nbWlanEntry 1 }

wlanModuleName OBJECT-TYPE
SYNTAX      DisplayString
MAX-ACCESS  read-only
STATUS      current
DESCRIPTION
    "WLAN module name"
 ::= { nbWlanEntry 2 }

wlanModuleType OBJECT-TYPE
SYNTAX      DisplayString
MAX-ACCESS  read-only

```

```

STATUS      current
DESCRIPTION
    "WLAN module type"
::= { nbWlanEntry 3 }

wlanNumClients OBJECT-TYPE
SYNTAX      Integer32
MAX-ACCESS  read-only
STATUS      current
DESCRIPTION
    "Current number of clients connected to the WLAN module in access-point mode"
::= { nbWlanEntry 4 }

wlanModuleChannel OBJECT-TYPE
SYNTAX      Integer32
MAX-ACCESS  read-only
STATUS      current
DESCRIPTION
    "Current channel of the WLAN module"
::= { nbWlanEntry 5 }

wlanModuleFrequency OBJECT-TYPE
SYNTAX      Integer32
UNITS       "MHz"
MAX-ACCESS  read-only
STATUS      current
DESCRIPTION
    "Current frequency of the WLAN module"
::= { nbWlanEntry 6 }

wlanSignalStrength OBJECT-TYPE
SYNTAX      Integer32
UNITS       "dBm"
MAX-ACCESS  read-only
STATUS      current
DESCRIPTION
    "Current signal strength of the WLAN module in client mode"
::= { nbWlanEntry 7 }

-- *****
-- NBWlanStationTable
-- *****

nbWlanStationTable OBJECT-TYPE
SYNTAX      SEQUENCE OF NBWlanStationEntry
MAX-ACCESS  not-accessible
STATUS      current
DESCRIPTION
    "A table shows current connected clients "
::= { nb 61 }

nbWlanStationEntry OBJECT-TYPE
SYNTAX      NBWlanStationEntry
MAX-ACCESS  not-accessible
STATUS      current
DESCRIPTION
    "An entry describes one connected client"
INDEX       { wlanStationIndex }
::= { nbWlanStationTable 1 }

NBWlanStationEntry ::= SEQUENCE {
    wlanStationIndex Integer32,
    wlanStationInterface DisplayString,
    wlanStationMac DisplayString,
    wlanStationSignalStrength Integer32,
    wlanStationBitrate Integer32,
    wlanStationRxBytes Counter64,
    wlanStationTxBytes Counter64,
    wlanStationInactive Integer32
}

wlanStationIndex OBJECT-TYPE
SYNTAX      Integer32(0..254)
MAX-ACCESS  not-accessible
STATUS      current
DESCRIPTION
    "WLAN station index"
::= { nbWlanStationEntry 1 }

wlanStationInterface OBJECT-TYPE
SYNTAX      DisplayString
MAX-ACCESS  read-only
STATUS      current
DESCRIPTION
    "The WLAN interface name"
::= { nbWlanStationEntry 2 }

wlanStationMac OBJECT-TYPE
SYNTAX      DisplayString
MAX-ACCESS  read-only

```



```

STATUS      current
DESCRIPTION
    "The MAC address of a connected station"
::= { nbWlanStationEntry 3 }

wlanStationSignalStrength OBJECT-TYPE
SYNTAX      Integer32
UNITS       "dBm"
MAX-ACCESS  read-only
STATUS      current
DESCRIPTION
    "The signal strength of a connected station"
::= { nbWlanStationEntry 4 }

wlanStationBitrate OBJECT-TYPE
SYNTAX      Integer32
UNITS       "Mbit/s"
MAX-ACCESS  read-only
STATUS      current
DESCRIPTION
    "The bitrate of a connected station"
::= { nbWlanStationEntry 5 }

wlanStationRxBytes OBJECT-TYPE
SYNTAX      Counter64
UNITS       "bytes"
MAX-ACCESS  read-only
STATUS      current
DESCRIPTION
    "The number of received bytes of a connected station"
::= { nbWlanStationEntry 6 }

wlanStationTxBytes OBJECT-TYPE
SYNTAX      Counter64
UNITS       "bytes"
MAX-ACCESS  read-only
STATUS      current
DESCRIPTION
    "The number of transmitted bytes of a connected station"
::= { nbWlanStationEntry 7 }

wlanStationInactive OBJECT-TYPE
SYNTAX      Integer32
UNITS       "ms"
MAX-ACCESS  read-only
STATUS      current
DESCRIPTION
    "The inactivity time of a connected station"
::= { nbWlanStationEntry 8 }

-- *****
-- NBWanTable
-- *****

nbHotLink OBJECT-TYPE
SYNTAX      DisplayString
MAX-ACCESS  read-only
STATUS      current
DESCRIPTION
    "The active WAN link"
::= { nb 70 }

nbWanTable OBJECT-TYPE
SYNTAX      SEQUENCE OF NBWanEntry
MAX-ACCESS  not-accessible
STATUS      current
DESCRIPTION "The table describing any WAN link and their current status"
::= { nb 71 }

nbWanEntry OBJECT-TYPE
SYNTAX      NBWanEntry
MAX-ACCESS  not-accessible
STATUS      current
DESCRIPTION "An entry describing a WAN link and its current status"
INDEX       { wanLinkIndex }
::= { nbWanTable 1 }

NBWanEntry ::= SEQUENCE {
    wanLinkIndex Integer32,
    wanLinkName  DisplayString,
    wanLinkState DisplayString,
    wanLinkSince DisplayString,
    wanLinkType  DisplayString,
    wanLinkInterface DisplayString,
    wanLinkAddress DisplayString,
    wanLinkGateway DisplayString,
    wanLinkNetmask DisplayString,
    wanDialAttempts Integer32,
    wanDialSuccess  Integer32,

```

```

wanDialFailures Integer32,
wanDataDownloaded Counter64,
wanDataUploaded Counter64,
wanDownloadRate Integer32,
wanUploadRate Integer32,
wanDataDownloadedRoaming Counter64,
wanDataUploadedRoaming Counter64
}

wanLinkIndex OBJECT-TYPE
    SYNTAX      Integer32(0..254)
    MAX-ACCESS  not-accessible
    STATUS      current
    DESCRIPTION
        "WAN link index"
    ::= { nbWanEntry 1 }

wanLinkName OBJECT-TYPE
    SYNTAX      DisplayString
    MAX-ACCESS  read-only
    STATUS      current
    DESCRIPTION
        "WAN link name"
    ::= { nbWanEntry 2 }

wanLinkState OBJECT-TYPE
    SYNTAX      DisplayString
    MAX-ACCESS  read-only
    STATUS      current
    DESCRIPTION
        "WAN link state"
    ::= { nbWanEntry 3 }

wanLinkSince OBJECT-TYPE
    SYNTAX      DisplayString
    MAX-ACCESS  read-only
    STATUS      current
    DESCRIPTION
        "WAN link since up"
    ::= { nbWanEntry 4 }

wanLinkType OBJECT-TYPE
    SYNTAX      DisplayString
    MAX-ACCESS  read-only
    STATUS      current
    DESCRIPTION
        "WAN link type"
    ::= { nbWanEntry 5 }

wanLinkInterface OBJECT-TYPE
    SYNTAX      DisplayString
    MAX-ACCESS  read-only
    STATUS      current
    DESCRIPTION
        "WAN link interface"
    ::= { nbWanEntry 6 }

wanLinkAddress OBJECT-TYPE
    SYNTAX      DisplayString
    MAX-ACCESS  read-only
    STATUS      current
    DESCRIPTION
        "WAN link address"
    ::= { nbWanEntry 7 }

wanLinkGateway OBJECT-TYPE
    SYNTAX      DisplayString
    MAX-ACCESS  read-only
    STATUS      current
    DESCRIPTION
        "WAN link gateway"
    ::= { nbWanEntry 8 }

wanLinkNetmask OBJECT-TYPE
    SYNTAX      DisplayString
    MAX-ACCESS  read-only
    STATUS      current
    DESCRIPTION
        "WAN link netmask"
    ::= { nbWanEntry 9 }

wanDialAttempts OBJECT-TYPE
    SYNTAX      Integer32
    MAX-ACCESS  read-only
    STATUS      current
    DESCRIPTION
        "WAN link dial attempts"
    ::= { nbWanEntry 10 }

wanDialSuccess OBJECT-TYPE

```

```

SYNTAX      Integer32
MAX-ACCESS  read-only
STATUS      current
DESCRIPTION
    "WAN link dial success"
 ::= { nbWanEntry 11 }

wanDialFailures OBJECT-TYPE
SYNTAX      Integer32
MAX-ACCESS  read-only
STATUS      current
DESCRIPTION
    "WAN link dial failures"
 ::= { nbWanEntry 12 }

wanDataDownloaded OBJECT-TYPE
SYNTAX      Counter64
UNITS       "bytes"
MAX-ACCESS  read-only
STATUS      current
DESCRIPTION
    "WAN link data downloaded"
 ::= { nbWanEntry 13 }

wanDataUploaded OBJECT-TYPE
SYNTAX      Counter64
UNITS       "bytes"
MAX-ACCESS  read-only
STATUS      current
DESCRIPTION
    "WAN link data uploaded"
 ::= { nbWanEntry 14 }

wanDownloadRate OBJECT-TYPE
SYNTAX      Integer32
MAX-ACCESS  read-only
STATUS      current
DESCRIPTION
    "WAN link download rate"
 ::= { nbWanEntry 15 }

wanUploadRate OBJECT-TYPE
SYNTAX      Integer32
MAX-ACCESS  read-only
STATUS      current
DESCRIPTION
    "WAN link upload rate"
 ::= { nbWanEntry 16 }

wanDataDownloadedRoaming OBJECT-TYPE
SYNTAX      Counter64
UNITS       "bytes"
MAX-ACCESS  read-only
STATUS      current
DESCRIPTION
    "WAN link data downloaded during roaming"
 ::= { nbWanEntry 17 }

wanDataUploadedRoaming OBJECT-TYPE
SYNTAX      Counter64
UNITS       "bytes"
MAX-ACCESS  read-only
STATUS      current
DESCRIPTION
    "WAN link data uploaded during roaming"
 ::= { nbWanEntry 18 }

-- *****
-- NBDioTable
-- *****

dioStatusIn1 OBJECT-TYPE
SYNTAX      INTEGER {
                off (0),
                on (1)
            }
MAX-ACCESS  read-only
STATUS      current
DESCRIPTION
    "The current value of digital I/O port IN1"
 ::= { dio 1 }

dioStatusIn2 OBJECT-TYPE
SYNTAX      INTEGER {
                off (0),

```

```

        }
        on (1)
    }
    MAX-ACCESS read-only
    STATUS current
    DESCRIPTION
        "The current value of digital I/O port IN2"
    ::= { dio 2 }

dioStatusOut1 OBJECT-TYPE
    SYNTAX INTEGER {
        off (0),
        on (1)
    }
    MAX-ACCESS read-only
    STATUS current
    DESCRIPTION
        "The current value of digital I/O port OUT1"
    ::= { dio 3 }

dioStatusOut2 OBJECT-TYPE
    SYNTAX INTEGER {
        off (0),
        on (1)
    }
    MAX-ACCESS read-only
    STATUS current
    DESCRIPTION
        "The current value of digital I/O port OUT2"
    ::= { dio 4 }

dioSetOUT1 OBJECT-TYPE
    SYNTAX INTEGER {
        off (0),
        on (1)
    }
    MAX-ACCESS read-write
    STATUS current
    DESCRIPTION
        "The update value for digital I/O port OUT1"
    ::= { dio 10 }

dioSetOUT2 OBJECT-TYPE
    SYNTAX INTEGER {
        off (0),
        on (1)
    }
    MAX-ACCESS read-write
    STATUS current
    DESCRIPTION
        "The update value for digital I/O port OUT2"
    ::= { dio 11 }

-- *****
-- NBSerialTable
-- *****

nbSerialTable OBJECT-TYPE
    SYNTAX SEQUENCE OF NBSerialEntry
    MAX-ACCESS not-accessible
    STATUS current
    DESCRIPTION
        "The table describing any serial ports and their current statistics"
    ::= { nb 54 }

nbSerialEntry OBJECT-TYPE
    SYNTAX NBSerialEntry
    MAX-ACCESS not-accessible
    STATUS current
    DESCRIPTION
        "An entry describing a serial port and its current statistics"
    INDEX { serialIndex }
    ::= { nbSerialTable 1 }

NBSerialEntry ::= SEQUENCE {
    serialIndex Integer32,
    serialName DisplayString,
    serialState Integer32,
    serialRxBytes Integer32,
    serialTxBytes Integer32,
    serialFrameErrors Integer32,
    serialOverrunErrors Integer32,
    serialParityErrors Integer32,
    serialBrkErrors Integer32,
    serialBufferOverrunErrors Integer32
}

serialIndex OBJECT-TYPE
    SYNTAX Integer32(0..254)
    MAX-ACCESS not-accessible

```

```

STATUS      current
DESCRIPTION
  "Serial port index"
 ::= { nbSerialEntry 1 }

serialName OBJECT-TYPE
SYNTAX      DisplayString
MAX-ACCESS  read-only
STATUS      current
DESCRIPTION
  "Serial port name"
 ::= { nbSerialEntry 2 }

serialState OBJECT-TYPE
SYNTAX      Integer32
MAX-ACCESS  read-only
STATUS      current
DESCRIPTION
  "The current state of the serial port"
 ::= { nbSerialEntry 3 }

serialRxBytes OBJECT-TYPE
SYNTAX      Integer32
MAX-ACCESS  read-only
STATUS      current
DESCRIPTION
  "The number of bytes received on the serial port"
 ::= { nbSerialEntry 4 }

serialTxBytes OBJECT-TYPE
SYNTAX      Integer32
MAX-ACCESS  read-only
STATUS      current
DESCRIPTION
  "The number of bytes transmitted on the serial port"
 ::= { nbSerialEntry 5 }

serialFrameErrors OBJECT-TYPE
SYNTAX      Integer32
MAX-ACCESS  read-only
STATUS      current
DESCRIPTION
  "The number of frame errors on the serial port"
 ::= { nbSerialEntry 6 }

serialOverrunErrors OBJECT-TYPE
SYNTAX      Integer32
MAX-ACCESS  read-only
STATUS      current
DESCRIPTION
  "The number of overrun errors on the serial port"
 ::= { nbSerialEntry 7 }

serialParityErrors OBJECT-TYPE
SYNTAX      Integer32
MAX-ACCESS  read-only
STATUS      current
DESCRIPTION
  "The number of parity errors on the serial port"
 ::= { nbSerialEntry 8 }

serialBrkErrors OBJECT-TYPE
SYNTAX      Integer32
MAX-ACCESS  read-only
STATUS      current
DESCRIPTION
  "The number of BRK errors on the serial port"
 ::= { nbSerialEntry 9 }

serialBufferOverrunErrors OBJECT-TYPE
SYNTAX      Integer32
MAX-ACCESS  read-only
STATUS      current
DESCRIPTION
  "The number of buffer overrun errors on the serial port"
 ::= { nbSerialEntry 10 }

-- *****
-- NBTrapHistoryTable
-- *****

nbTrapHistoryTable OBJECT-TYPE
SYNTAX      SEQUENCE OF NBTrapHistoryEntry
MAX-ACCESS  not-accessible
STATUS      current
DESCRIPTION
  "This table shows the last SNMP Traps"
 ::= { nb 80 }

```

```

nbTrapHistoryEntry OBJECT-TYPE
SYNTAX      NBTrapHistoryEntry
MAX-ACCESS  not-accessible
STATUS      current
DESCRIPTION
    "An entry describing an occurred SNMP trap"
INDEX       { trapHistoryIndex }
 ::= { nbTrapHistoryTable 1 }

NBTrapHistoryEntry ::= SEQUENCE {
    trapHistoryIndex Integer32,
    trapHistoryTimestamp Counter64,
    trapHistoryUptime Counter64,
    trapHistoryEvent Integer32
}

trapHistoryIndex OBJECT-TYPE
SYNTAX      Integer32(0..254)
MAX-ACCESS  not-accessible
STATUS      current
DESCRIPTION
    "trap history index"
 ::= { nbTrapHistoryEntry 1 }

trapHistoryTimestamp OBJECT-TYPE
SYNTAX      Counter64
UNITS       "seconds"
MAX-ACCESS  read-only
STATUS      current
DESCRIPTION
    "The timestamp when the SNMP occurred"
 ::= { nbTrapHistoryEntry 2 }

trapHistoryUptime OBJECT-TYPE
SYNTAX      Counter64
UNITS       "seconds"
MAX-ACCESS  read-only
STATUS      current
DESCRIPTION
    "The uptime of the router when the SNMP trap occurred"
 ::= { nbTrapHistoryEntry 3 }

trapHistoryEvent OBJECT-TYPE
SYNTAX      Integer32
MAX-ACCESS  read-only
STATUS      current
DESCRIPTION
    "The event type of the SNMP trap"
 ::= { nbTrapHistoryEntry 4 }

-- *****
-- trap objects
-- *****

events          OBJECT IDENTIFIER ::= { traps 0 }

sdk-trap NOTIFICATION-TYPE
STATUS      current
DESCRIPTION "SDK trap"
 ::= { events 1 }

wan-up NOTIFICATION-TYPE
STATUS      current
DESCRIPTION "WAN link came up"
 ::= { events 101 }

wan-down NOTIFICATION-TYPE
STATUS      current
DESCRIPTION "WAN link went down"
 ::= { events 102 }

dio-in1-on NOTIFICATION-TYPE
STATUS      current
DESCRIPTION "DIO IN1 turned on"
 ::= { events 201 }

dio-in1-off NOTIFICATION-TYPE
STATUS      current
DESCRIPTION "DIO IN1 turned off"
 ::= { events 202 }

dio-in2-on NOTIFICATION-TYPE
STATUS      current
DESCRIPTION "DIO IN2 turned on"
 ::= { events 203 }

dio-in2-off NOTIFICATION-TYPE
STATUS      current
DESCRIPTION "DIO IN2 turned off"
 ::= { events 204 }

```

```
dio-out1-on NOTIFICATION-TYPE
STATUS current
DESCRIPTION "DIO OUT1 turned on"
::= { events 205 }

dio-out1-off NOTIFICATION-TYPE
STATUS current
DESCRIPTION "DIO OUT1 turned off"
::= { events 206 }

dio-out2-on NOTIFICATION-TYPE
STATUS current
DESCRIPTION "DIO OUT2 turned on"
::= { events 207 }

dio-out2-off NOTIFICATION-TYPE
STATUS current
DESCRIPTION "DIO OUT2 turned off"
::= { events 208 }

gps-up NOTIFICATION-TYPE
STATUS current
DESCRIPTION "GPS signal is available"
::= { events 301 }

gps-down NOTIFICATION-TYPE
STATUS current
DESCRIPTION "GPS signal is not available"
::= { events 302 }

openvpn-up NOTIFICATION-TYPE
STATUS current
DESCRIPTION "OpenVPN connection came up"
::= { events 401 }

openvpn-down NOTIFICATION-TYPE
STATUS current
DESCRIPTION "OpenVPN connection went down"
::= { events 402 }

ipsec-up NOTIFICATION-TYPE
STATUS current
DESCRIPTION "IPsec connection came up"
::= { events 403 }

ipsec-down NOTIFICATION-TYPE
STATUS current
DESCRIPTION "IPsec connection went down"
::= { events 404 }

pptp-up NOTIFICATION-TYPE
STATUS current
DESCRIPTION "PPTP connection came up"
::= { events 406 }

pptp-down NOTIFICATION-TYPE
STATUS current
DESCRIPTION "PPTP connection went down"
::= { events 407 }

dialin-up NOTIFICATION-TYPE
STATUS current
DESCRIPTION "Dial-In connection came up"
::= { events 408 }

dialin-down NOTIFICATION-TYPE
STATUS current
DESCRIPTION "Dial-In connection went down"
::= { events 409 }

mobileip-up NOTIFICATION-TYPE
STATUS current
DESCRIPTION "Mobile IP connection came up"
::= { events 410 }

mobileip-down NOTIFICATION-TYPE
STATUS current
DESCRIPTION "Mobile IP connection went down"
::= { events 411 }

gre-up NOTIFICATION-TYPE
STATUS current
DESCRIPTION "GRE connection came up"
::= { events 412 }

gre-down NOTIFICATION-TYPE
STATUS current
DESCRIPTION "GRE connection went down"
::= { events 413 }
```

```
system-login-failed NOTIFICATION-TYPE
STATUS current
DESCRIPTION "User login failed"
::= { events 501 }

system-login-succeeded NOTIFICATION-TYPE
STATUS current
DESCRIPTION "User login succeeded"
::= { events 502 }

system-logout NOTIFICATION-TYPE
STATUS current
DESCRIPTION "User logged out"
::= { events 503 }

system-rebooting NOTIFICATION-TYPE
STATUS current
DESCRIPTION "System reboot has been triggered"
::= { events 504 }

system-startup NOTIFICATION-TYPE
STATUS current
DESCRIPTION "System has been started"
::= { events 505 }

test NOTIFICATION-TYPE
STATUS current
DESCRIPTION "test event"
::= { events 506 }

sdk-startup NOTIFICATION-TYPE
STATUS current
DESCRIPTION "SDK has been started"
::= { events 507 }

system-time-updated NOTIFICATION-TYPE
STATUS current
DESCRIPTION "System time has been updated"
::= { events 508 }

system-poweroff NOTIFICATION-TYPE
STATUS current
DESCRIPTION "System poweroff has been triggered"
::= { events 509 }

system-error NOTIFICATION-TYPE
STATUS current
DESCRIPTION "System is in error state"
::= { events 510 }

system-no-error NOTIFICATION-TYPE
STATUS current
DESCRIPTION "System left error state"
::= { events 511 }

sms-sent NOTIFICATION-TYPE
STATUS current
DESCRIPTION "SMS has been sent"
::= { events 601 }

sms-notsent NOTIFICATION-TYPE
STATUS current
DESCRIPTION "SMS has not been sent"
::= { events 602 }

sms-received NOTIFICATION-TYPE
STATUS current
DESCRIPTION "SMS has been received"
::= { events 603 }

sms-report-received NOTIFICATION-TYPE
STATUS current
DESCRIPTION "SMS report has been received"
::= { events 604 }

call-incoming NOTIFICATION-TYPE
STATUS current
DESCRIPTION "A voice call is coming in"
::= { events 701 }

call-outgoing NOTIFICATION-TYPE
STATUS current
DESCRIPTION "Outgoing voice call is being established"
::= { events 702 }

ddns-update-succeeded NOTIFICATION-TYPE
STATUS current
DESCRIPTION "Dynamic DNS update succeeded"
::= { events 801 }
```



```
ddns-update-failed NOTIFICATION-TYPE
STATUS current
DESCRIPTION "Dynamic DNS update failed"
::= { events 802 }

usb-storage-added NOTIFICATION-TYPE
STATUS current
DESCRIPTION "USB storage device has been added"
::= { events 901 }

usb-storage-removed NOTIFICATION-TYPE
STATUS current
DESCRIPTION "USB storage device has been removed"
::= { events 902 }

usb-eth-added NOTIFICATION-TYPE
STATUS current
DESCRIPTION "USB Ethernet device has been added"
::= { events 903 }

usb-eth-removed NOTIFICATION-TYPE
STATUS current
DESCRIPTION "USB Ethernet device has been removed"
::= { events 904 }

usb-serial-added NOTIFICATION-TYPE
STATUS current
DESCRIPTION "USB serial device has been added"
::= { events 905 }

usb-serial-removed NOTIFICATION-TYPE
STATUS current
DESCRIPTION "USB serial device has been removed"
::= { events 906 }

redundancy-master NOTIFICATION-TYPE
STATUS current
DESCRIPTION "System is now master router"
::= { events 1001 }

redundancy-backup NOTIFICATION-TYPE
STATUS current
DESCRIPTION "System is now backup router"
::= { events 1002 }

END
```

A.5. SDK Examples

| Event | Description |
|----------------------------|---|
| best-operator.are | This script will scan for operators on startup and choose the one with the best signal |
| candump.are | This script can be used to receive CAN messages |
| config-summary.are | This script shows a summary of the currently running configuration. |
| dio-monitor.are | This script monitors the DIO ports and sends a SMS to the specified phone number. |
| dio-server.are | This script implements a TCP server which can be used to control the DIO ports. |
| dio.are | This script can be used to set a digital output port. |
| dynamic-operator.are | This script will scan Mobile2 and dial the appropriate SIM on Mobile1 |
| email-to-sms.are | This script implements a lightweight SMTP server which is able to receive mail and forward them as SMS to a phone number. |
| etherwake.are | This script can be used to wake up a sleeping host (WakeOn-Lan) |
| gps-broadcast.are | This script sends the local GPS NMEA stream to a remote UDP server (incl. device identity). |
| gps-monitor.are | A script for activating WLAN as soon as GPS position (lat,lon) is within a specified range. |
| gps-udp-client-compat.are | This script sends the local GPS NMEA stream (incl. serial/checksum) to a remote UDP server. |
| gps-udp-client.are | This script sends the local GPS NMEA stream to a remote UDP server. |
| led.are | This script can be used to set a LED |
| modbus-rtu-master.are | This script can be used to read messages from the serial port. |
| modbus-rtu-slave.are | This script implements a modbus slave server |
| modbus-tcp-rtu-gateway.are | This script implements a Modbus TCP RTU gateway |
| mount-media.are | This script can be used to mount an USB storage stick. |
| opcua-browse.are | This script will browse for nodes at a remote OPC-UA server. |
| opcua-json.are | This script polls any temperature nodes of an OPC-UA server and sends them JSON-encoded to a remote server. |
| opcua-read.are | This script will read the node value at a OPC-UA server. |

| Event | Description |
|--------------------------|---|
| opcua-write.are | This script will write a new value to a node at a OPC-UA server. |
| ping-supervision.are | This script will supervise a specified host. |
| read-config.are | This script can be used to read a configuration parameter. |
| remote-mail.are | This script reads and sends mails from a remote IMAP/POP3/SMTP server |
| scan-mobile.are | This script can be used to switch the Mobile LAI according to available networks |
| scan-wlan.are | This script can be used to switch the WLAN client network according to availability |
| send-mail.are | This script will send an E-Mail to the specified address. |
| send-sms.are | This script will send an SMS to the specified phone number. |
| send-techsupport.are | This script will generate a techsupport and send it to the specified E-Mail address. |
| serial-read.are | This script can be used to read messages from the serial port. |
| serial-readwrite.are | This script will write to and read from the serial port. |
| serial-tcp-broadcast.are | This script reads messages coming from the serial port and forwards them via TCP to remote hosts (and vice versa). |
| serial-tcsetattr.are | This script can be used to set/get the attributes of the serial port. |
| serial-udp-server.are | This script reads messages coming from the serial port and forwards them via UDP to a remote host (and vice versa). |
| serial-write.are | This script can be used to write a message to the serial port. |
| set-ipsec-route.are | set route to IPSEC server depending on active WWAN / WLAN network |
| sms-confirm.are | This script will send out a message and confirm its delivery. |
| sms-control.are | This script will execute commands received by SMS. |
| sms-delete-inbox.are | This script can be used to flush the SMS inbox. |
| sms-read-inbox.are | This script can be used to read the SMS inbox. |
| sms-to-email.are | This script will forward incoming SMS messages to a given E-mail address. |
| sms-to-serial.are | This script can be used to write a received SMS to the serial port. |
| snmp-agent.are | This script extends MIB entries of the SNMP agent |
| snmp-cmd.are | This script issues SNMP set/get commands |

| Event | Description |
|----------------------------|--|
| snmp-trap.are | This script can be used to send SNMP traps |
| status.are | This script can be used to display all status variables |
| syslog.are | Throw a simple syslog message. |
| tcpclient.are | This script sends a message to a TCP server. |
| tcpserver.are | This script implements a TCP server which is able to receive messages. |
| techsupport.are | This transfers a techsupport to a remote FTP server |
| transfer-file.are | This scripts archives a remote file |
| transfer.are | This scripts stores the latest GNSS positions in a remote FTP file |
| udp-msg-server.are | This script will run an UDP server which is able to receive messages and forward them as SMS/E-Mail. |
| udpclient.are | This script sends a message to a remote UDP server. |
| udpserver.are | This script implements an UDP server which is able to receive messages. |
| update-config.are | This script can be used to perform a configuration update |
| voice-dispatcher-audio.are | This script implements an audio voice dispatcher |
| webpage.are | This script will generate a page which can be viewed in the Web Manager |
| write-config.are | This script can be used to set a configuration parameter. |

Table A.3.: SDK Examples